

SL4800 Interior Layout

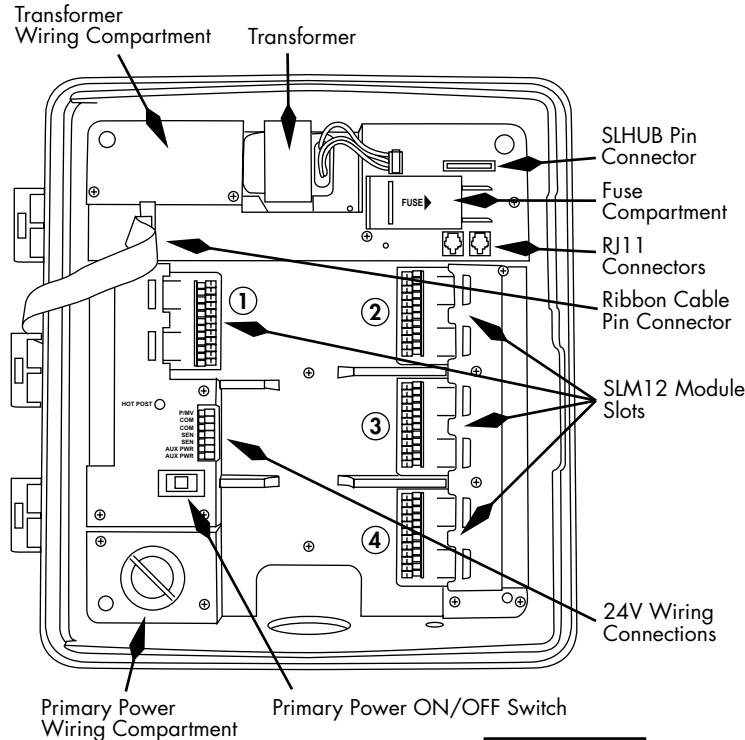

Bottom View

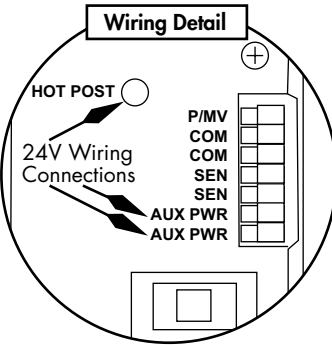
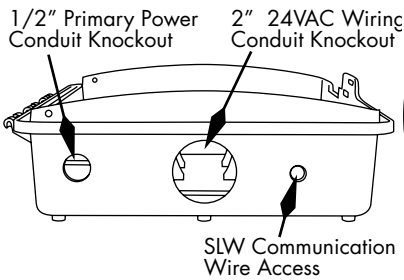

1. Mounting the SL4800

All SL4800 controller housings are designed for indoor or outdoor installation. Your SL4800 controller can be located in any convenient spot providing access to the system wiring and power supply. Wall mount or pedestal enclosure mount can be utilized by purchasing the optional SLPED-ENC. It is recommended that you choose a location where the irrigation system will not be spraying directly on the controller, in the event that the housing door is left open.

- Open the controller's front door. Grasp the 90 degree tab at the top of the stainless steel hinge pin and lift the pin out of the hinge channel. Set the door and hinge pin aside during mounting.
- Next, open the large hinged control panel door and disconnect the ribbon cable from the pin connector located above zone module slot 1. Then pull up on the spring loaded pin at the bottom of the panel and then tilt the bottom of the panel outward so that

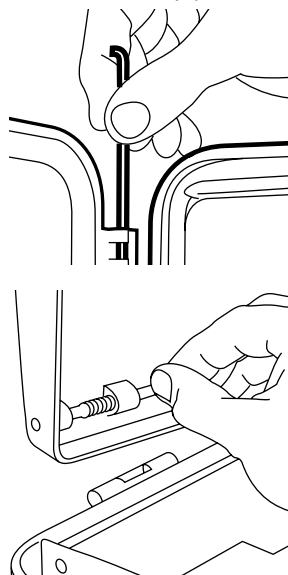

the panel hinge pin at the top drops out of the retaining hole in the housing. Set the control panel door aside in a safe place. Note: The SLCP control panel does not need to be removed from the control panel door during Installation.

- If you are mounting the SL4800 in an enclosure pedestal, see the instructions provided with the pedestal as well as refer to the instructions given on this sheet.
- 2. Wallmount for the SL4800**
- 1/4" screws and 5/16" masonry anchors are provided.
 - Determine mounting height for easy viewing and be sure to mount low enough for field wires to reach all controller wiring terminals.
 - Using one of the 1/4" mounting screws (or a pencil) mark the location of the top/center keyhole onto the wall (see photo below).

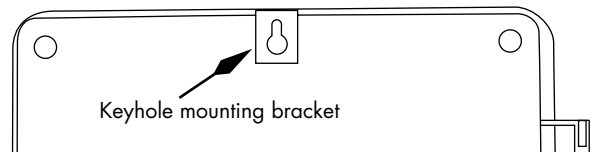

- Using a 5/16" drill, install a wall anchor in the marked position then install the mounting screw into the anchor. Allow the screw head to protrude from the anchor just enough for a firm fit inside the keyhole. Align controller housing for a level fit on the wall. Insert 1/4" screws (provided) into each of the 4 mounting holes at each corner of the housing and drive the screws through the housing and into the wall to mark each screw location. Remove the screws and the housing from the wall and drill 5/16" holes for the rest of the screw anchors. Insert anchors in the wall. Remount the controller housing on the keyhole and re-insert and tighten the rest of the mounting screws into the anchors. Note: A mounting position for a sixth screw is provided at the bottom of the housing for optional use.

3. SLM12 Module Installation

- Your SL4800 controller is factory equipped with one SLM12 12-zone module. You may add three additional SLM12 modules for a total of 48 zones. Important: Do not skip any module slot. Insert all modules in numerical order as shown in the illustration.
- Upon firmly closing the control panel, the SL4800 controller will automatically recognize the additional zones as they are installed. No special programming or resetting is required to initialize the modules.
- You can insert or remove a module without removing power from the controller.
- To install a module, push the module into the slots until you feel it lock in place. To remove a module, push DOWN on the release tabs at the back of the module and use the top tab at the front of the module to pull it out.



4. AC Power Wiring

Warning: Connecting the SL4800 controller to the primary power should be done by a licensed electrician following all local codes. To prevent electrical shock, go to the electrical supply breaker box and make sure the circuit breaker to be used is OFF before connecting the power supply wiring. Electrical shock can cause severe injury or death. This controller is not intended for use by children. Do not allow children to play with the controller.

- Remove the two screws that secure the AC Wiring Cavity Panel. This will allow access to the primary wiring terminal.
- Make sure the ON/OFF AC POWER SWITCH located just above the wiring cavity is in the OFF position during wiring.

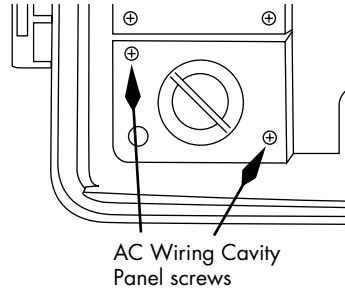

- Utilize code approved conduit fixtures for the primary power supply wiring.
- The AC terminal is marked for Neutral, Earth Ground, 120V and 230V connections. For 120V/60Hz power supply, connect ground to the GREEN or Copper wire; connect Neutral to the WHITE wire and 120V to the BLACK wire. For 230V connection, check your local codes for wire colors for Earth Ground, Neutral and 230V.
- Replace the AC Wire Cavity Panel and secure with the screws.

- Return to the breaker box and turn on the circuit breaker. Return to the SL4800 and turn the AC ON/OFF switch to the ON position. Check the power indication light located under the fuse compartment. If wiring is successful and the power is on, you will see a GREEN light. If no light is visible, re-check your wiring. If fuse is blown, the light will be RED.

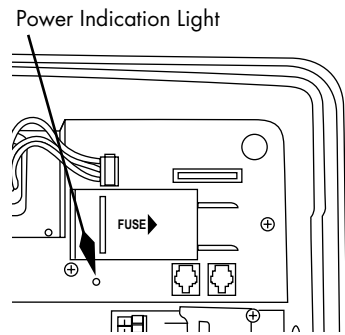

- Power requirement Information: Current draw for the SL4800 in idle mode with 48 zones utilized is 60 mA on a 120VAC line.

5. 24VAC Valve Wiring

WARNING: Never mix 24VAC and high voltage wiring in the same conduit.

- For solid wires, simply push to insert the stripped end of valve wire into the module connector.
- For stranded wires, use a small screwdriver blade to slide back the orange trigger first, then insert the stranded wire while still holding the trigger in the open position. When you release the orange trigger, the wire will lock in place. Confirm connection by pulling the wire.
- COM (Valve Common): Two valve commons are provided on the SL4800. Connect the Valve Common wires to either COM terminal.

- MV/P (Master Valve/Pump Terminal): Connect one wire to a COM position and the second wire to the MV/P position. Polarity is not important. Note that the total current of the activated Pump Start Relay and valve(s) cannot exceed the maximum output current (default is 1.6A).
- SEN (Rain/Freeze/Wind Sensor): If you are using an optional rain, freeze, or wind sensor, use the SEN terminals for these devices. There is no polarity required for these wires. Remove and discard the factory installed wire jumper. Note: If you are using an SLW weather station with the SL4800, the wire jumper must remain in place in the SEN terminals. It should only be removed if a sensor is connected to the terminals. Otherwise, no watering will occur and you will have a constant RED light on the control panel Sensor Active LED. Note: When using a wireless Rain/Freeze/Wind Sensor (see AUX PWR). Auxiliary devices must have a "normally closed" switch or the sensor LED needs to be in the bypass mode.

- AUX PWR: Terminals are provided for auxiliary power connections requiring 24V power for operating auxiliary devices such as wireless sensors.
- Zone Wires: Connect each zone wire to a terminal on an SLM12 Module. Your SL4800 controller can power a total of 5 valves concurrently or a total of 4 valves with one master valve or pump start. Take caution when running a pump start relay so maximum output current does not exceed .6A. To locate each zone, touch zone wire to the HOT POST and determine which zone valve is ON. Note that the HOT POST is HOT even when the control panel is not in the housing.

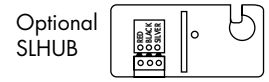

- SLHUB: If an optional SLW weather station is being connected, install the SLHUB at the top right hand side of the SL4800 according to the instructions included with the SLHUB.

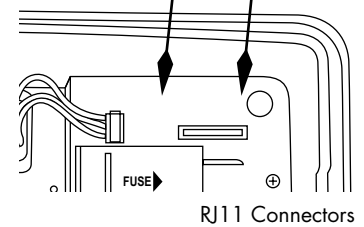

- RJ11: Two RJ11 connectors are provided for use with optional wireless receivers and future communication links. Housing knockouts for RJ11 cable access are provided.

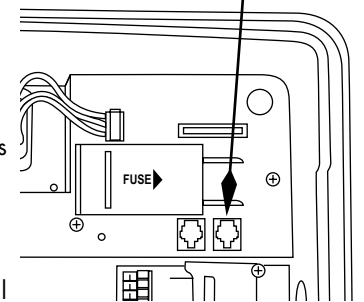

6. Control Panel Installation

- With the controller and optional SLW installation complete, re-insert the control panel door into the housing. Reconnect the ribbon cable and lock the retaining tabs.

Installation is complete! Proceed to your Owner's Manual to program your controller.

