



Accessories for ECHO products can be found at:

Los accesorios para los productos ECHO se pueden encontrar en:

www.echo-usa.com/products/catalogs

OPTIONAL ACCESSORIES &

ATTACHMENTS:

3 Ft. Extension 99946400010

GUIDE BARS AND CHAINS:

10" Guide Bar - (0.050" Ga) 10A0CD3739

10" Saw Chain - (0.050" Ga) 91VXL39CQ

10" Guide Bar - (0.043" Ga) 10A4CD3739

10" Saw Chain - (0.043" Ga) 90PX39CQ

12" Guide Bar - (0.050" Ga) 12A0CD3744

12" Saw Chain - (0.050" Ga) 91VXL44CQ

12" Guide Bar - (0.043" Ga) 12A4CD3744

12" Saw Chain - (0.043" Ga) 90PX44CQ

ACCESORIOS & ACCESORIOS

OPCIONALES:

3 Ft. Extensión 99946400010

BARRAS GUÍA Y CADENAS:

Barra Guía - 10" (0.050" Ga) 10A0CD3739

Cadena de Sierra - 10" (0.050" Ga) 91VXL39CQ

Barra Guía - 10" (0.043" Ga) 10A4CD3739

Cadena de Sierra - 10" (0.043" Ga) 90PX39CQ

Barra Guía - 12" (0.050" Ga) 12A0CD3744

Cadena de Sierra - 12" (0.050" Ga) 91VXL44CQ

Barra Guía - 12" (0.043" Ga) 12A4CD3744

Cadena de Sierra - 12" (0.043" Ga) 90PX44CQ

PARTS CATALOG LISTA DE PIEZAS

PPF-225 Power Pruner

PPF-225 Podadora Motorizada



21.2 cc

SERIAL NUMBER
NÚMERO DE SERIE

S63311001001 - S63311999999

ECHO, INCORPORATED

400 Oakwood Road, Lake Zurich, Illinois 60047

WWW.ECHO-USA.COM

©2015 ECHO, Incorporated. All Rights Reserved

P/N 99922200773
REVISED 07/30/15

Engine Covers 3 Cubiertas del Motor	Gear Case, Auto-Oiler 20 Caja de Engranajes, Auto-Lubricador
Engine 4 Motor	Gear Case, Auto-Oiler 21 Caja de Engranajes, Auto-Lubricador
Engine 5 Motor	Guide Bar, Sawing Chain, Guide Bar Cover ... 22 Barra Guía, Cadena de Sierra, Funda
Carburetor 6 Carburador	Shoulder Strap 23 Correa de hombro
Carburetor 7 Carburador	Labels 24 Etiquetas
Intake 8 Admisión	Tools 25 Herramientas
Exhaust 9 Escape	RePower Maintenance Kits 26 Kits de Mantenimiento RePower
Ignition S/N S63311001001 - S63311002696 ... 10 Encendido N/S S63311001001 - S63311002696	
Ignition S/N S63311002697 - S63311999999 ... 11 Encendido N/S S63311002697 - S63311999999	
Starter 12 Arrancador	
Fuel System S/N S63311001001 - S63311002972 13 Sistema de combustible N/S S63311001001 - S63311002972	
Fuel System S/N S63311002973 - S63311999999 14 Sistema de combustible N/S S63311002973 - S63311999999	
Fan Case 15 Carcasa del Ventilador	
Main Pipe 16 Tubo Principle	
Control Handle S/N S63311001001 - S63311004255 17 Mango de Control N/S S63311001001 - S63311004255	
Control Handle S/N S63311004256 - S63311010168 18 Mango de Control N/S S63311004256 - S63311010168	
Control Handle S/N S63311010169 - S63311999999 19 Mango de Control N/S S63311010169 - S63311999999	

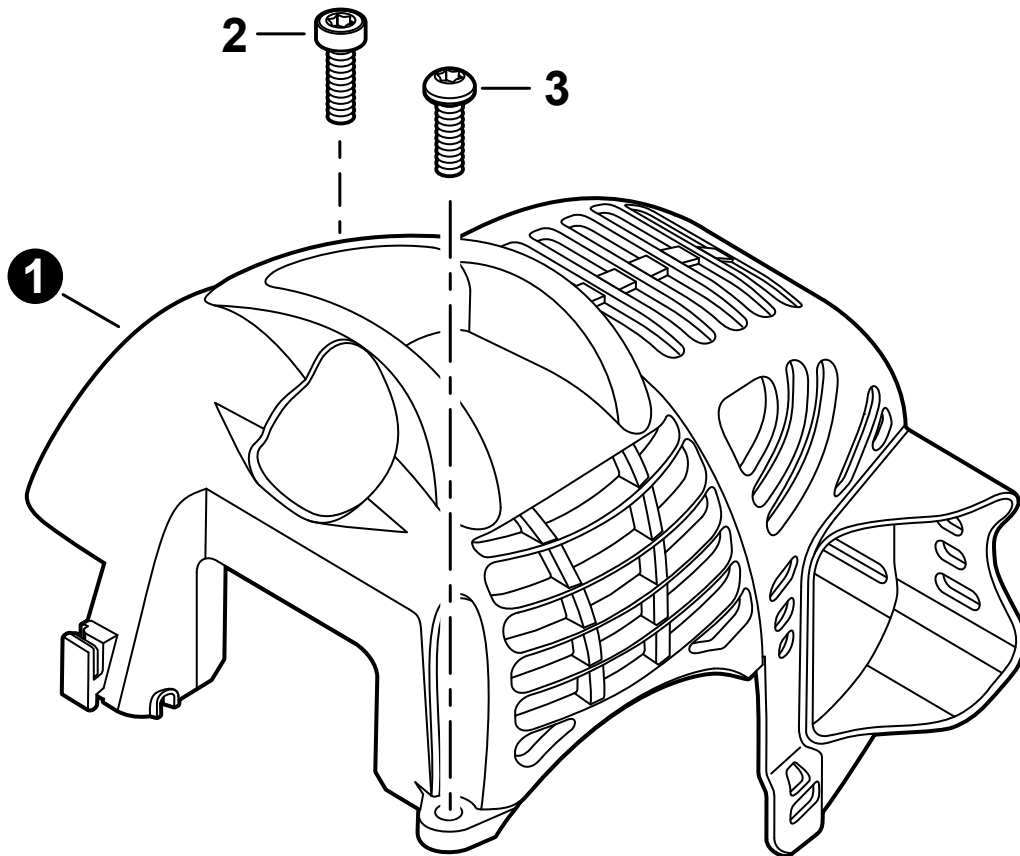

NO.	PART NUMBER	QTY.	DESCRIPTION	DESCRIPCIÓN
1	A160001090	1	COVER, ENGINE	CUBIERTA DEL MOTOR
2	V805000150	1	BOLT, TORX 5×16	PERNO TORX 5×16
3	V805000000	1	BOLT, TORX 5×16	PERNO TORX 5×16

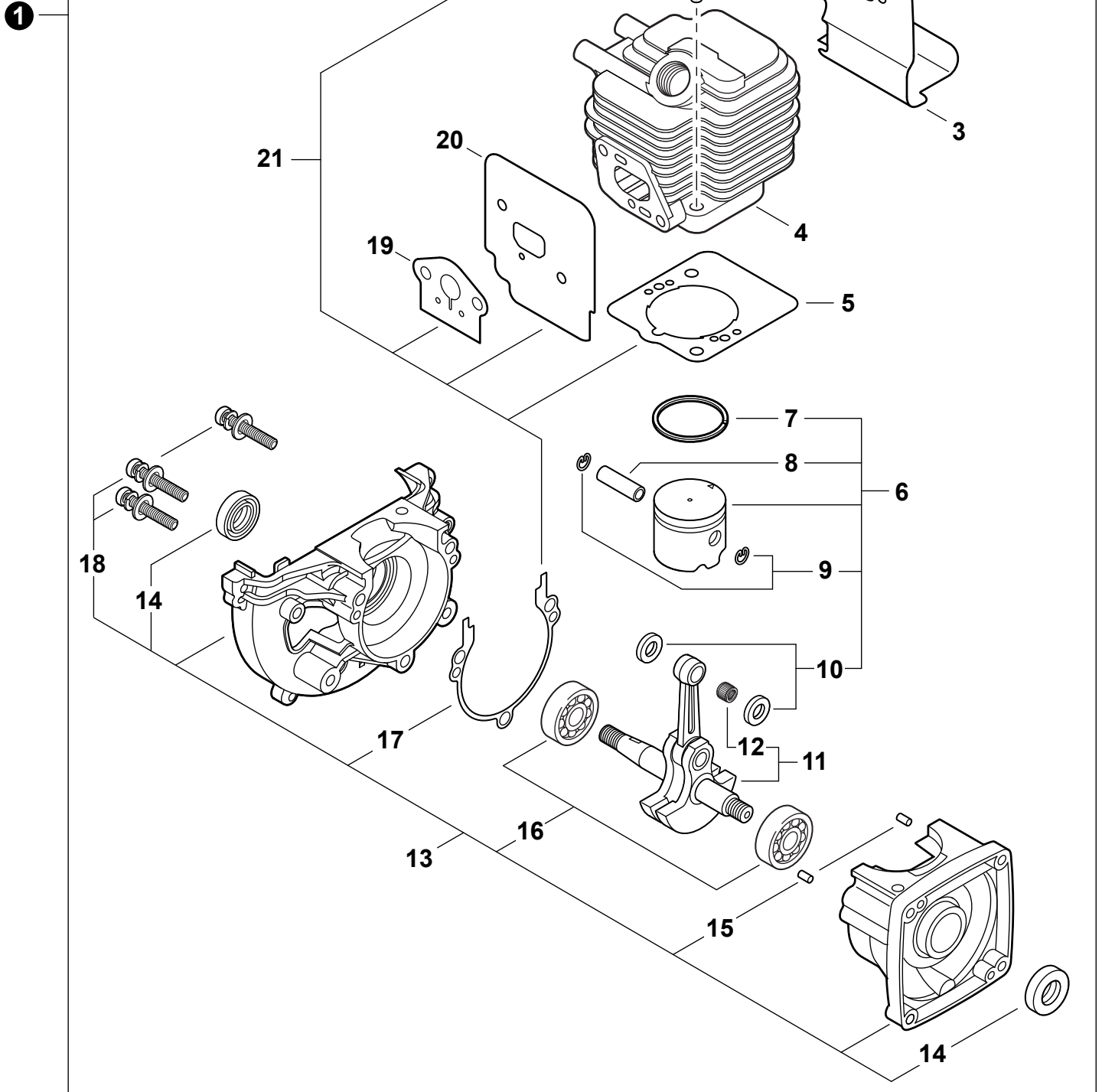

NO.	PART NUMBER	QTY.	DESCRIPTION	DESCRIPCIÓN
1	SB1096	1	SHORT BLOCK	BLOQUE CORTO
2	90016205022	2	+BOLT 5×22	+PERNO 5×22
3	V104000850	1	+GASKET, EXHAUST	+EMPAQUETADURA DE ESCAPE
4	A130000540	1	+CYLINDER	+CILINDRO
5	V100000160	1	+GASKET, CYLINDER	+EMPAQUETADURA DE CILINDRO
6	P021007712	1	+PISTON KIT	+JUEGO DE PISTÓN
7	A101000090	1	++RING, PISTON	++ANILLO DEL PISTÓN
8	10001311520	1	++PIN, PISTON 5×8×25.5	++PASADOR DEL PISTÓN 5×8×25.5
9	10001504630	2	++RING, SNAP	++ANILLO RETENEDOR
10	10001411520	2	++WASHER, THRUST 8.2×13×0.5	++ARANDELA DE EMPUJE 8.2×13×0.5
11	A011000101	1	+CRANKSHAFT ASSY	+MONTAJE DE CIGÜEÑAL
12	V553000060	1	++BEARING, NEEDLE 8	++COJINETE DE AGUJAS 8
13	10020452133	1	+CRANKCASE KIT	+JUEGO DE CÁRTER
14	10021242031	2	++SEAL, OIL 12	++SELLO DE ACEITE 12
15	90033040080	2	++PIN, LOCATING 4×8	++PASADOR DE POSICIONAMIENTO 4×8
16	9403536201	2	++BEARING, BALL 6201	++COJINETE DE BALINES 6201
17	10024242030	1	++GASKET, CRANKCASE	++EMPAQUETADURA DE CÁRTER
18	90016205028	3	++BOLT 5×28	++PERNO 5×28
19	V103001500	1	+GASKET, INTAKE	+EMPAQUETADURA DE ADMISIÓN
20	V103001360	1	+GASKET, INTAKE	+EMPAQUETADURA DE ADMISIÓN
21	P021015981	1	GASKET KIT	JUEGO DE EMPAQUETADURA

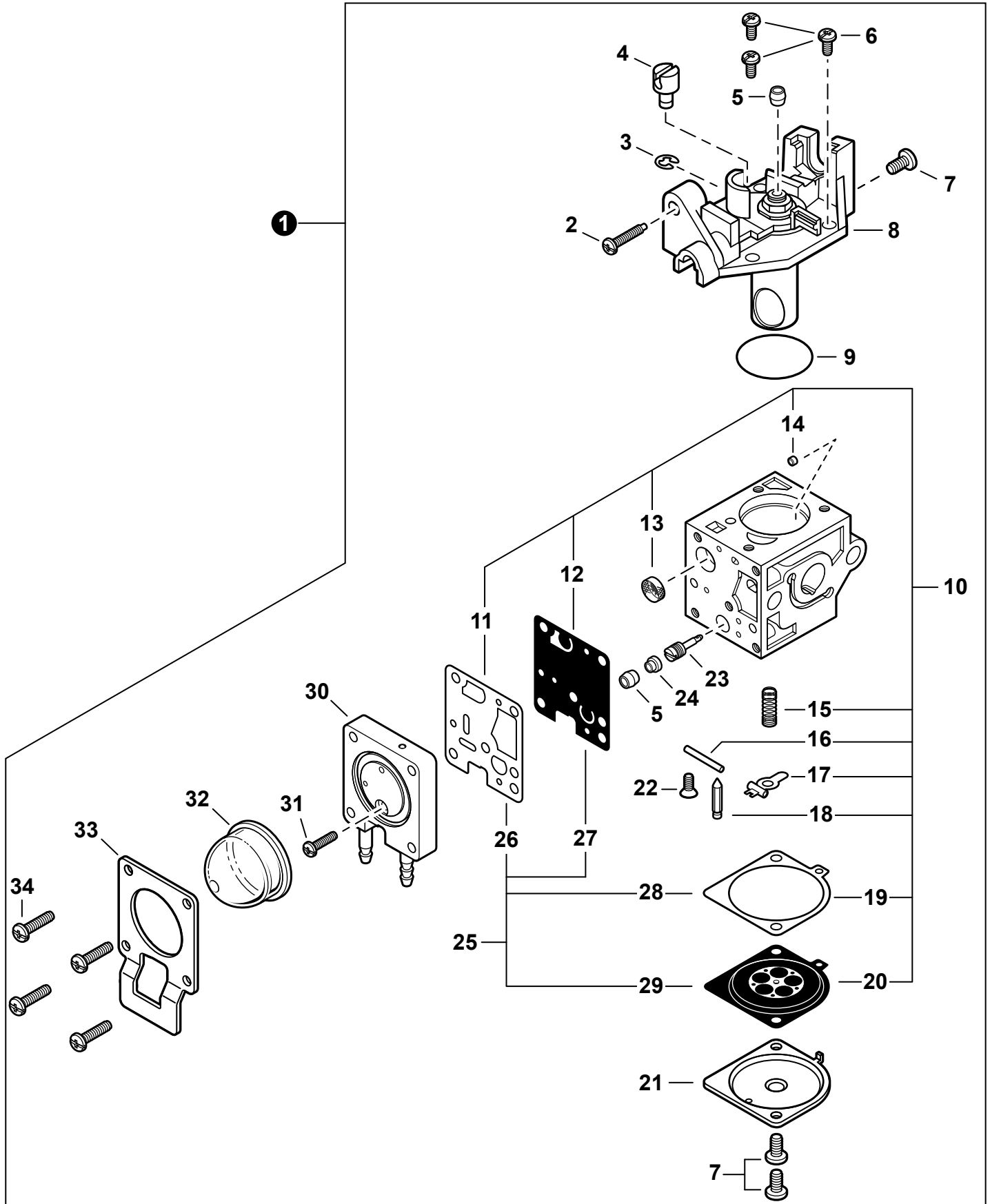

NO.	PART NUMBER	QTY.	DESCRIPTION	DESCRIPCIÓN
1	A021001692	1	CARBURETOR - RB-K93	CARBURADOR - RB-K93
2	P005000100	1	+SCREW, THROTTLE ADJUST	+TORNILLO AJUSTE DE TENSION DEL ACELERADOR
3	P005000190	1	+E-RING	+RETENEDOR TIPO "E"
4	P005002090	1	+SWIVEL	+CONECTOR GIRATORIO
5	P005001270	2	+CAP, LIMITER	+PROTECTOR DE TORNILLO
6	12534413931	3	+SCREW	+TORNILLO
7	12534452130	3	+SCREW	+TORNILLO
8	P005002050	1	+COVER ASSY, ROTOR	+MONTAJE DE CUBIERTA DE ROTOR
9	P005000280	1	+O-RING	+JUNTA TÓRICA
10	P005002280	1	+REPAIR KIT	+JUEGO DE REPARACIÓN
11		1	++GASKET, PUMP	++EMPAQUETADURA DE LA BOMBA
12		1	++DIAPHRAGM, PUMP	++DIAFRAGMA DE LA BOMBA
13		1	++SCREEN, FUEL INLET	++MALLA FILTRADORA
14		1	++GUIDE, ROLLER	++GUÍA DE RODILLO
15		1	++SPRING, METERING LEVER	++RESORTE PALANCA DE MEDICIÓN
16		1	++PIN, METERING LEVER	++PASADOR DE PALANCA DE MEDICIÓN
17		1	++LEVER, METERING	++PALANCA DE MEDICIÓN
18		1	++VALVE, INLET NEEDLE	++VÁLVULA REGULADORA
19		1	++GASKET, METERING DIAPHRAGM	++EMPAQUETADURA DIAFRAGMA DE MEDICIÓN
20		1	++DIAPHRAGM, METERING	++DIAFRAGMA DE MEDICIÓN
21	12534252130	1	+COVER, METERING DIAPHRAGM	+TAPA DE DIAFRAGMA DE MEDICIÓN
22	12533942030	1	+SCREW	+TORNILLO
23	P005001260	1	+NEEDLE, HIGH SPEED	+AGUJA DE REGULACION ALTA (H)
24	P005001250	1	+PLUG	+TAPÓN
25	P005002270	1	+GASKET / DIAPHRAGM KIT	+JUEGO DE EMPAQUETADURA / DIAFRAGMAS
26		1	++GASKET, PUMP	++EMPAQUETADURA DE LA BOMBA
27		1	++DIAPHRAGM, PUMP	++DIAFRAGMA DE LA BOMBA
28		1	++GASKET, METERING DIAPHRAGM	++EMPAQUETADURA DIAFRAGMA DE MEDICIÓN
29		1	++DIAPHRAGM, METERING	++DIAFRAGMA DE MEDICIÓN
30	P005002480	1	+BODY ASSY, PURGE	+MONTAJE DE CUERPO DE PURGA
31	P005000270	1	+SCREW	+TORNILLO
32	P005003110	1	+BULB, PURGE	+BULBO DE PURGA
33	P005000250	1	+RETAINER, PURGE BULB	+SUJETADOR DE BULBO DE PURGA
34	P005001900	4	+SCREW	+TORNILLO

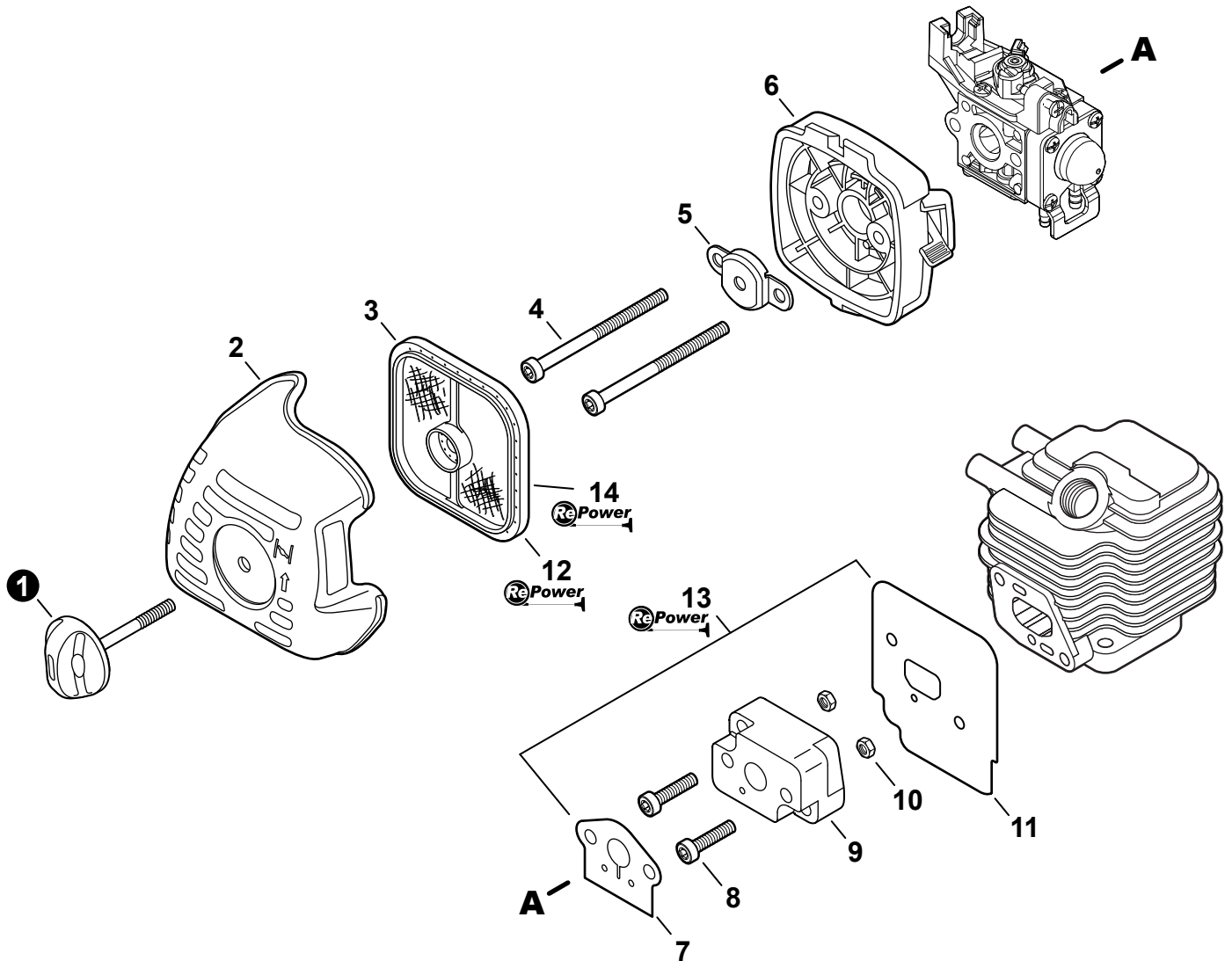

NO.	PART NUMBER	QTY.	DESCRIPTION	DESCRIPCIÓN
1	V299000250	1	THUMBSCREW	TORNILLO DE OREJETAS
2	A232000480	1	COVER, AIR FILTER	CUBIERTA DEL FILTRO DE AIRE
3	A226001410	1	FILTER, AIR - DOUBLE LAYER	FILTRO DE AIRE - CAPA DOBLE
4	V805000100	2	BOLT, TORX 5×65	PERNO TORX 5×65
5	12901152730	1	PLATE, PREVENT	PLACA DE PREVENCIÓN
6	P021012870	1	CASE ASSY, AIR FILTER	MONTAJE DE CAJA DEL FILTRO DE AIRE
7	V103001500	1	GASKET, INTAKE	EMPAQUETADURA DE ADMISIÓN
8	V805000160	2	BOLT, TORX 5×20	PERNO TORX 5×20
9	13001744331	1	INSULATOR, INTAKE	AISLADOR DE ADMISIÓN
10	90050000005	2	NUT 5	TUERCA 5
11	V103001360	1	GASKET, INTAKE	EMPAQUETADURA DE ADMISIÓN
12	90152	1	TUNE-UP KIT - REPOWER	JUEGO DE PUESTA A PUNTO - REPOWER
13	P021015981	1	GASKET KIT	JUEGO DE EMPAQUETADURA
14	90008	1	FILTER KIT - REPOWER	JUEGO DE FILTRO - REPOWER

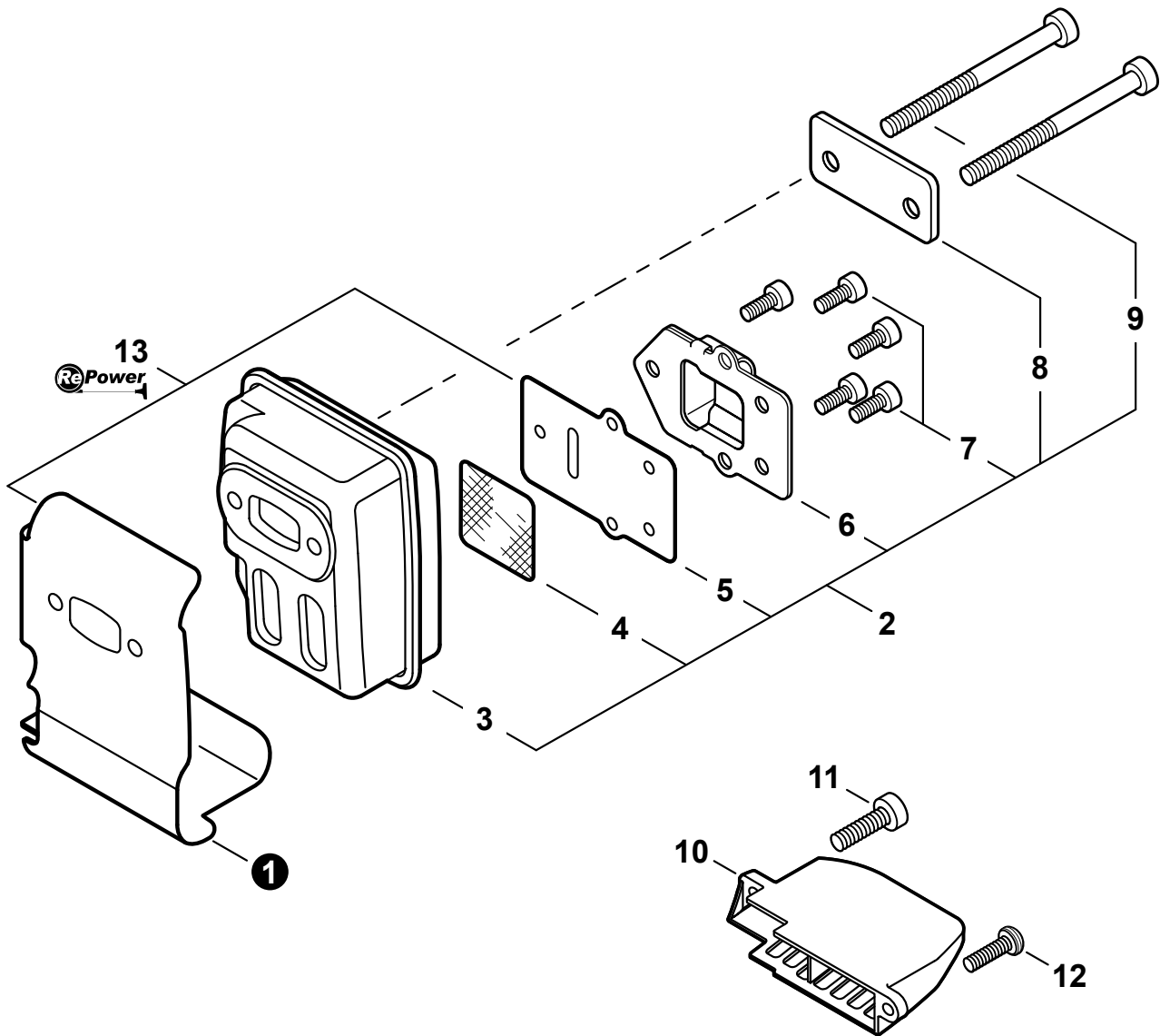

NO.	PART NUMBER	QTY.	DESCRIPTION	DESCRIPCIÓN
1	V104000850	1	GASKET, EXHAUST	EMPAQUETADURA DE ESCAPE
2	P021036111	1	MUFFLER ASSY	MONTAJE DE SILENCIADOR
3	A300000811	1	+MUFFLER	+SILENCIADOR
4	14586240630	1	+SCREEN, SPARK ARRESTER	+PANTALLA DEL GUARDACHISPAS
5	V104001760	1	+GASKET, EXHAUST	+EMPAQUETADURA DE ESCAPE
6	A313000600	1	+GUIDE, EXHAUST	+GUÍA DE ESCAPE
7	V804000030	5	+BOLT, TORX 4×8	+PERNO TORX 4×8
8	V150000371	1	+PLATE, EYE	+PLACA
9	V805000190	2	+BOLT, TORX 5×55	+PERNO TORX 5×55
10	A320000480	1	COVER, MUFFLER	CUBIERTA DEL SILENCIADOR
11	V805000150	1	BOLT, TORX 5×16	PERNO TORX 5×16
12	V805000000	1	BOLT, TORX 5×16	PERNO TORX 5×16
13	P021015981	1	GASKET KIT	JUEGO DE EMPAQUETADURA

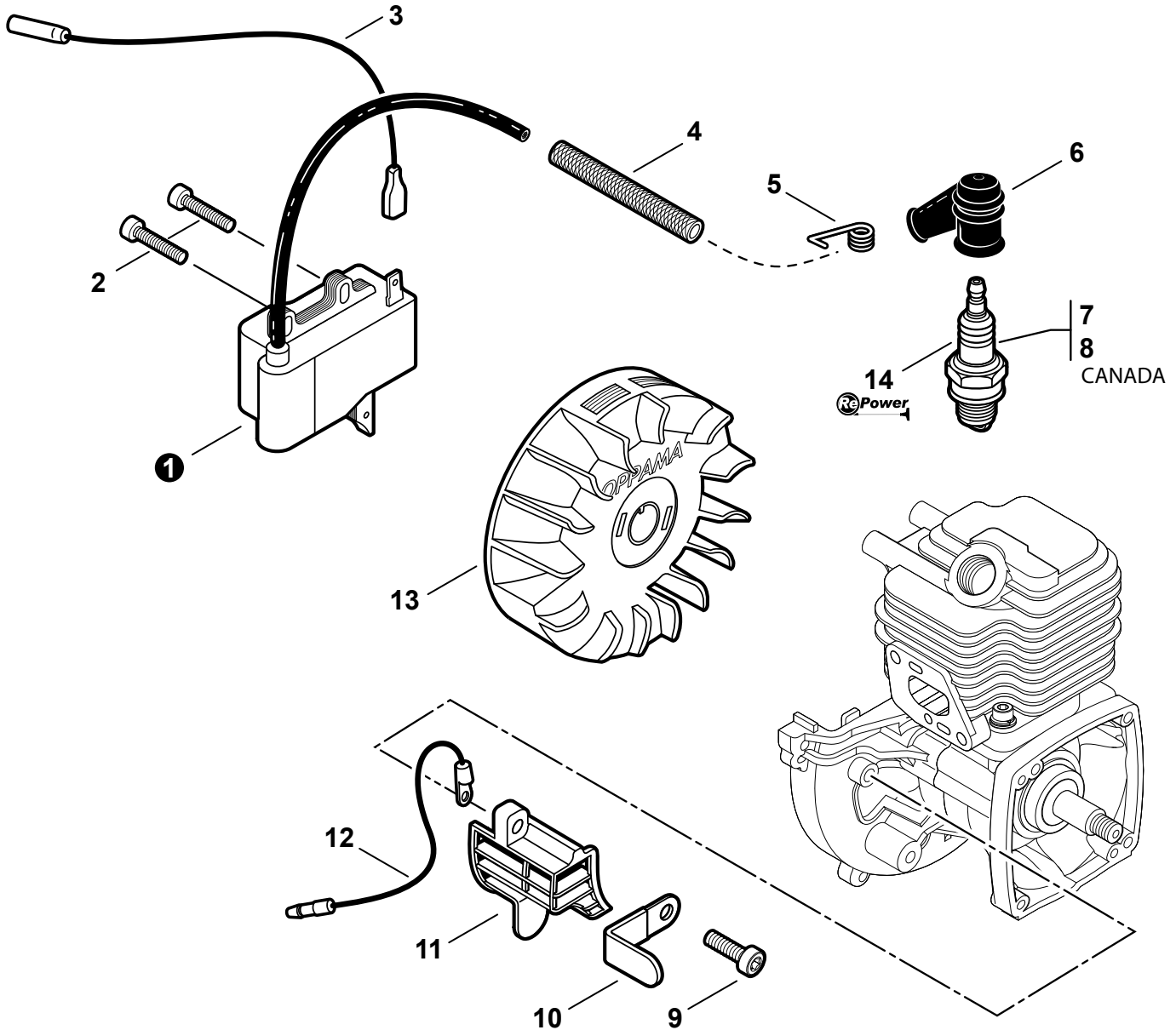

NO.	PART NUMBER	QTY.	DESCRIPTION	DESCRIPCIÓN
1	A411000130	1	COIL, IGNITION	BOBINA DE ENCENDIDO
2	V804000070	2	BOLT, TORX 4×20	PERNO TORX 4×20
3	V485001120	1	LEAD - IGNITION L= 210	CABLE DE ENCENDIDO L= 210
4	V475004160	1	PIPE, FUEL 7×8.6×65	TUBO DE COMBUSTIBLE 7×8.6×65
5	A426000010	1	TERMINAL, SPARK PLUG	TERMINAL DE BUJÍA
6	A427000013	1	CAP, SPARK PLUG	TAPA DE BUJÍA
7	15901019830	1	SPARK PLUG - BPM8Y	BUJÍA BPM8Y
8	A425000000	1	SPARK PLUG - BPMR8Y	BUJÍA BPMR8Y
9	V805000150	1	BOLT, TORX 5×16	PERNO TORX 5×16
10	15911621231	1	CLAMP	ABRAZADERA
11	A127000160	1	COVER, DUST	CUBIERTA ANTIPOLVO
12	16201427230	1	LEAD - GROUND L= 115	CABLE DE TIERRA L= 115
13	A409000210	1	FLYWHEEL	VOLANTE
14	90152	1	TUNE-UP KIT - REPOWER	JUEGO DE PUESTA A PUNTO - REPOWER

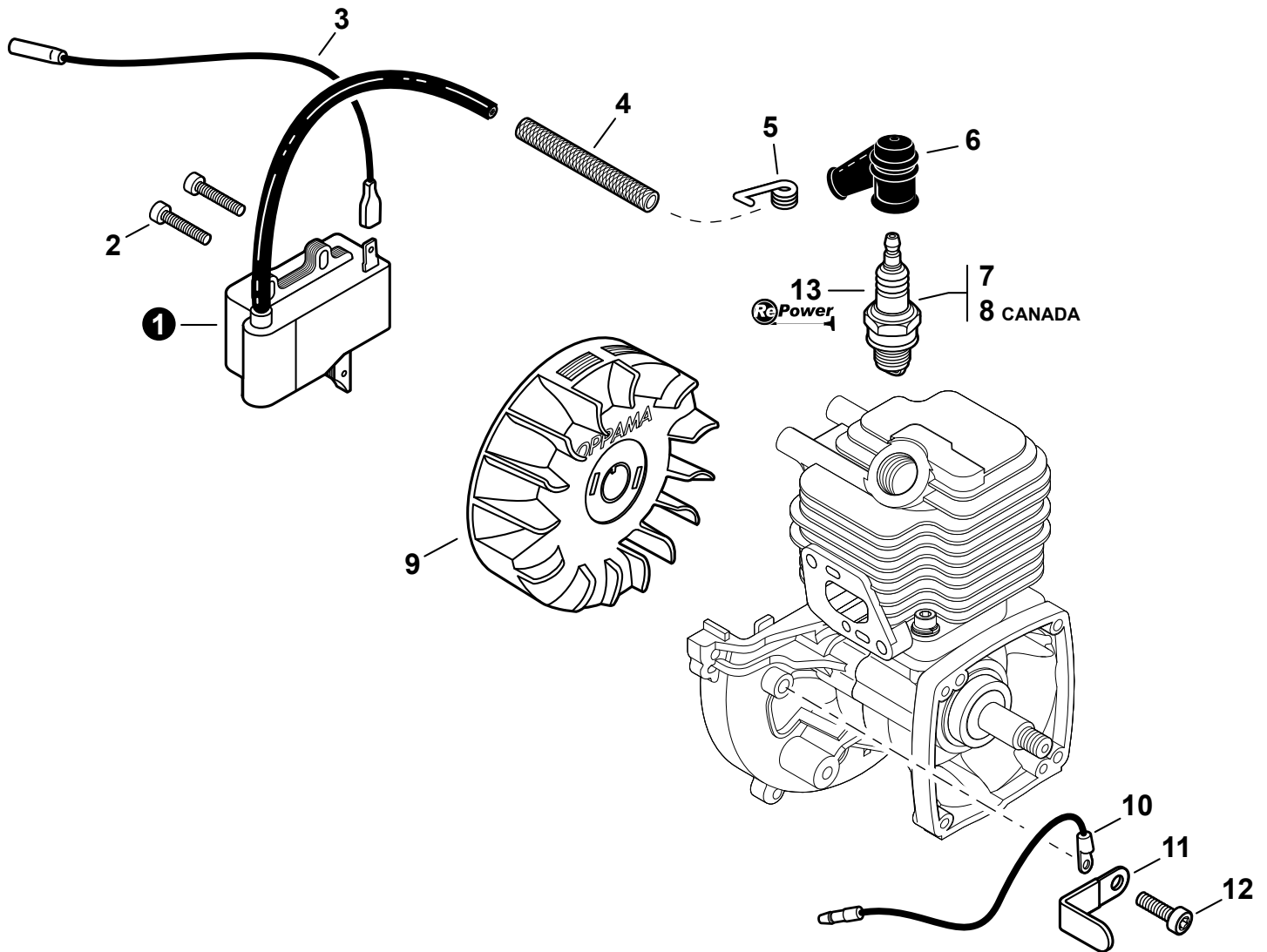

NO.	PART NUMBER	QTY.	DESCRIPTION	DESCRIPCIÓN
1	A411000130	1	COIL, IGNITION	BOBINA DE ENCENDIDO
2	V804000070	2	BOLT, TORX 4x20	PERNO TORX 4x20
3	V485001120	1	LEAD - IGNITION L= 210	CABLE DE ENCENDIDO L= 210
4	V475007200	1	TUBE, INSULATOR Ø8 L= 65	TUBO AISLANTE Ø8 L= 65
5	A426000010	1	TERMINAL, SPARK PLUG	TERMINAL DE BUJÍA
6	A427000013	1	CAP, SPARK PLUG	TAPA DE BUJÍA
7	15901019830	1	SPARK PLUG - BPM8Y	BUJÍA BPM8Y
8	A425000000	1	SPARK PLUG - BPMR8Y	BUJÍA BPMR8Y
9	A409000210	1	FLYWHEEL	VOLANTE
10	16201427230	1	LEAD - GROUND L= 115	CABLE DE TIERRA L= 115
11	15911621231	1	CLAMP	ABRAZADERA
12	V805000130	1	BOLT, TORX 5x10	PERNO TORX 5x10
13	90152	1	TUNE-UP KIT - REPOWER	JUEGO DE PUESTA A PUNTO - REPOWER

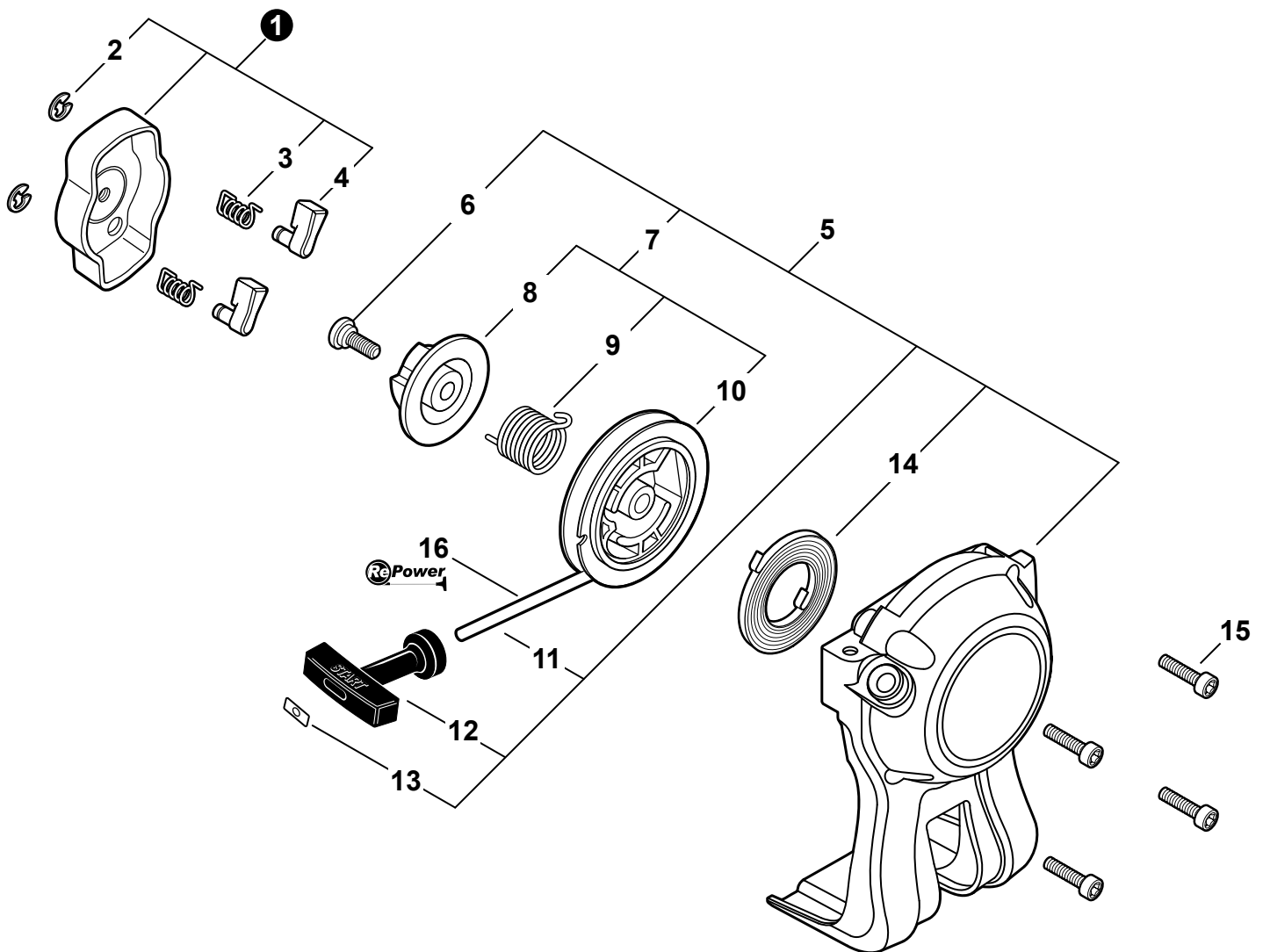

NO.	PART NUMBER	QTY.	DESCRIPTION	DESCRIPCIÓN
1	A052000180	1	PAWL ASSY, STARTER	MONTAJE DE TRINQUETE
2	P022002100	2	+E-RING 4	+RETENEDOR TIPO "E" 4
3	17723412220	2	+SPRING, RETURN	+RESORTE DE RETORNO
4	P022006850	2	+PAWL, STARTER	+TRINQUETE
5	A051001312	1	STARTER ASSY, RECOIL	MONTAJE DE ARRANCADOR AUTORRETRÁCTIL
6	17723661830	1	+SCREW	+TORNILLO
7	P050009920	1	+REEL KIT, ROPE	+JUEGO DE CARRETE DEL CABLE
8	A525000020	1	++PLATE, CAM	++PLACA DE LEVA
9	P022008270	1	++SPRING, TORSION	++RESORTE DE TORSIÓN
10	A506000500	1	++REEL, ROPE	++CARRETE DEL CABLE
11	P022019990	1	+ROPE, STARTER	+CUERDA DEL ARRANCADOR
12	17722827030	1	+GRIP, STARTER	+AGARRE DEL ARRANCADOR
13	17724611120	1	+RETAINER, ROPE	+RETENEDOR DE CUERDA
14	P022019680	1	+SPRING, RECOIL	+RESORTE RECULAR
15	V804000060	4	BOLT, TORX 4x16	PERNO TORX 4x16
16	99944440000	1	ROPE, STARTER - REPOWER BULK Ø3	CUERDA DEL ARRANCADOR REPOWER AL POR MAYOR

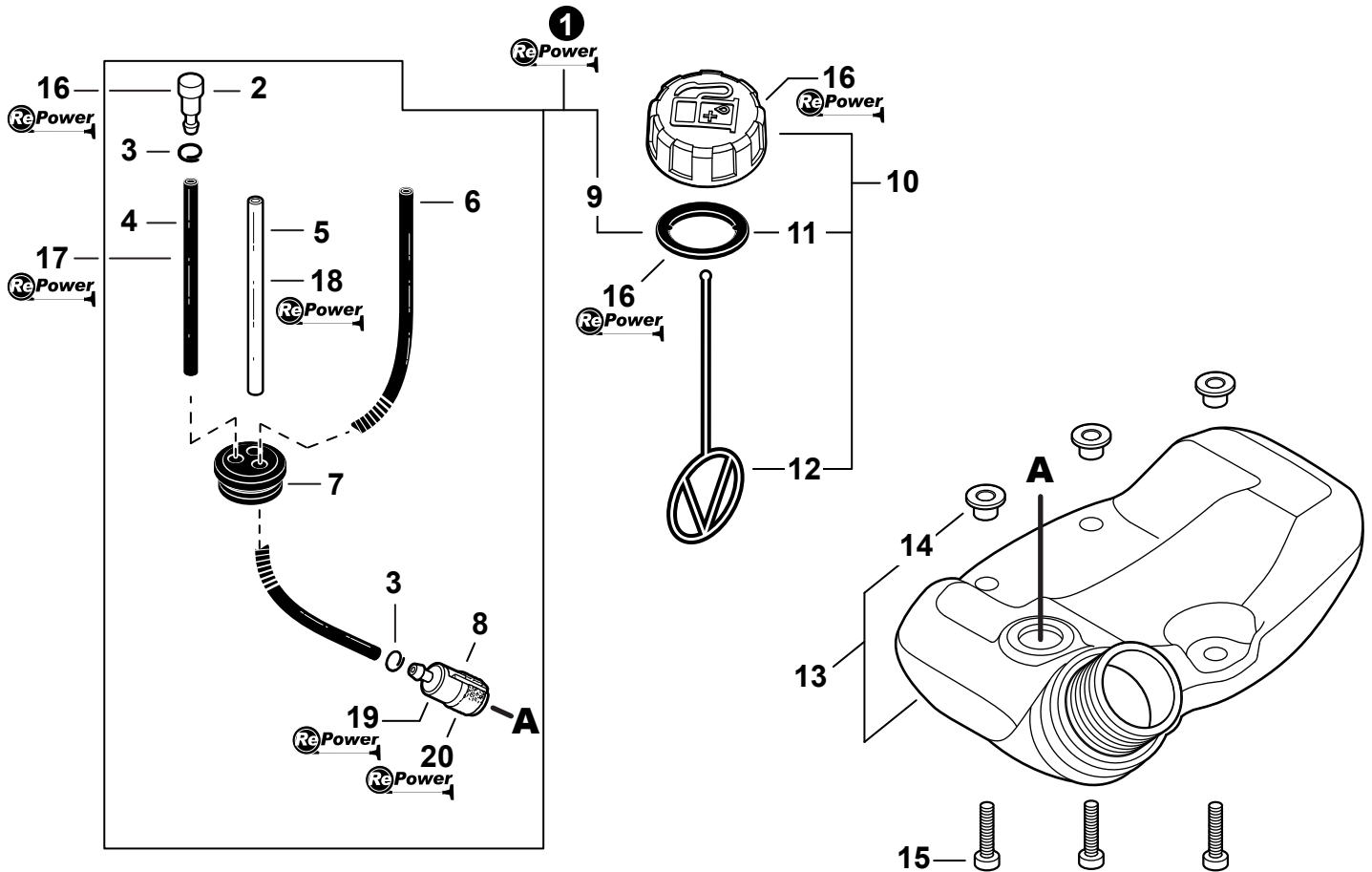

NO.	PART NUMBER	QTY.	DESCRIPTION	DESCRIPCIÓN
1	90117	1	FUEL SYSTEM KIT - REPOWER	KIT DEL SISTEMA DE COMBUSTIBLE - REPOWER
2	A356000031	1	+VENT ASSY	+VÁLVULA DE RESPIRADERO
3	13201309820	2	+CLIP 6MM	+SUJETADOR 6MM
4	V471001210	1	+PIPE, FUEL 3×5×90 BLACK	+TUBO DE COMBUSTIBLE 3×5×90 NEGRO
5	13201256030	1	+PIPE, FUEL 3×6×80 CLEAR	+TUBO DE COMBUSTIBLE 3×6×80 TRANSPARENTE
6	V470000840	1	+PIPE, FUEL	+TUBO DE COMBUSTIBLE
7	V137000030	1	+GROMMET, FUEL	+OJAL DE COMBUSTIBLE
8	13120507320	1	+FILTER, FUEL	+FILTRO DE COMBUSTIBLE
9	13101655830	1	+GASKET, FUEL CAP	+EMPAQUETADURA DEL TAPA DE COMBUSTIBLE
10	P021040430	1	CAP ASSY, FUEL	MONTAJE DE TAPA DE COMBUSTIBLE
11	13101655830	1	+GASKET, FUEL CAP	+EMPAQUETADURA DEL TAPA DE COMBUSTIBLE
12	A365000060	1	+CONNECTOR, CAP L= 123	+CONECTOR DE TAPA L= 123
13	A350000780	1	TANK ASSY, FUEL	MONTAJE DE TANQUE DE COMBUSTIBLE
14	V353000231	3	+COLLAR 5	+COLLAR 5
15	V805000160	3	BOLT, TORX 5×20	PERNO TORX 5×20
16	90248	1	CAP/VENT KIT - REPOWER	JUEGO DE TAPA Y RESPIRADERO - REPOWER
17	90014	1	PIPE, BULK - REPOWER 3×5mm BLACK	TUBO REPOWER AL POR MAYOR 3×5mm NEGRO
18	90017	1	PIPE, BULK - REPOWER 3×6mm CLEAR	TUBO REPOWER AL POR MAYOR 3×6mm TRANSPARENTE
19	90152	1	TUNE-UP KIT - REPOWER	JUEGO DE PUESTA A PUNTO - REPOWER
20	90008	1	FILTER KIT - REPOWER	JUEGO DE FILTRO - REPOWER

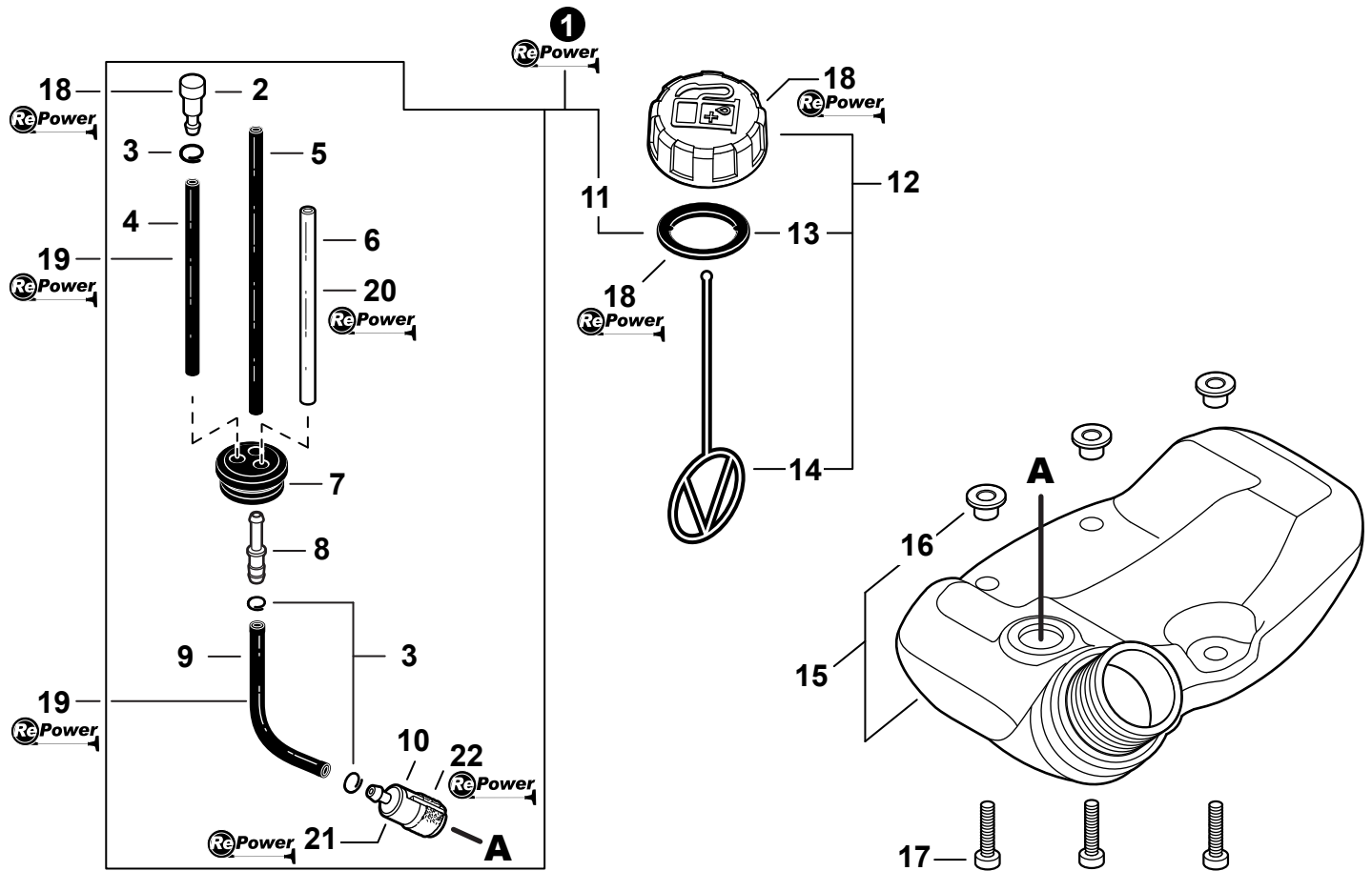

NO.	PART NUMBER	QTY.	DESCRIPTION	DESCRIPCIÓN
1	90139BP	1	FUEL SYSTEM KIT - REPOWER	KIT DEL SISTEMA DE COMBUSTIBLE - REPOWER
2	A356000031	1	+VENT ASSY	+VÁLVULA DE RESPIRADERO
3	V490001240	3	+CLIP Ø6	+SUJETADOR Ø6
4	V471001210	1	+PIPE, FUEL 3×5×90 BLACK	+TUBO DE COMBUSTIBLE 3×5×90 NEGRO
5	V471003691	1	+PIPE, FUEL 3×5×74 BLACK	+TUBO DE COMBUSTIBLE 3×5×74 NEGRO
6	13201256030	1	+PIPE, FUEL 3×6×80 CLEAR	+TUBO DE COMBUSTIBLE 3×6×80 TRANSPARENTE
7	13211546730	1	+GROMMET, FUEL Ø5	+OJAL DE COMBUSTIBLE Ø5
8	V186000520	1	+CONNECTOR, PIPE Ø5×Ø3.5	+CONECTOR DE TUBO Ø5×Ø3.5
9	V470001960	1	+PIPE, FUEL 3×5×110 BLACK	+TUBO DE COMBUSTIBLE 3×5×110 NEGRO
10	13120507321	1	+FILTER, FUEL	+FILTRO DE COMBUSTIBLE
11	V107000150	1	+GASKET, FUEL CAP	+EMPAQUETADURA DEL TAPA DE COMBUSTIBLE
12	P021040430	1	CAP ASSY, FUEL	MONTAJE DE TAPA DE COMBUSTIBLE
13	V107000150	1	+GASKET, FUEL CAP	+EMPAQUETADURA DEL TAPA DE COMBUSTIBLE
14	A365000060	1	+CONNECTOR, CAP L= 123	+CONECTOR DE TAPA L= 123
15	A350000780	1	TANK ASSY, FUEL	MONTAJE DE TANQUE DE COMBUSTIBLE
16	V353000231	3	+COLLAR 5	+COLLAR 5
17	V805000160	3	BOLT, TORX 5×20	PERNO TORX 5×20
18	90248	1	CAP/VENT KIT - REPOWER	JUEGO DE TAPA Y RESPIRADERO - REPOWER
19	90014	1	PIPE, BULK - REPOWER 3×5mm BLACK	TUBO REPOWER AL POR MAYOR 3×5mm NEGRO
20	90017	1	PIPE, BULK - REPOWER 3×6mm CLEAR	TUBO REPOWER AL POR MAYOR 3×6mm TRANSPARENTE
21	90152	1	TUNE-UP KIT - REPOWER	JUEGO DE PUESTA A PUNTO - REPOWER
22	90008	1	FILTER KIT - REPOWER	JUEGO DE FILTRO - REPOWER

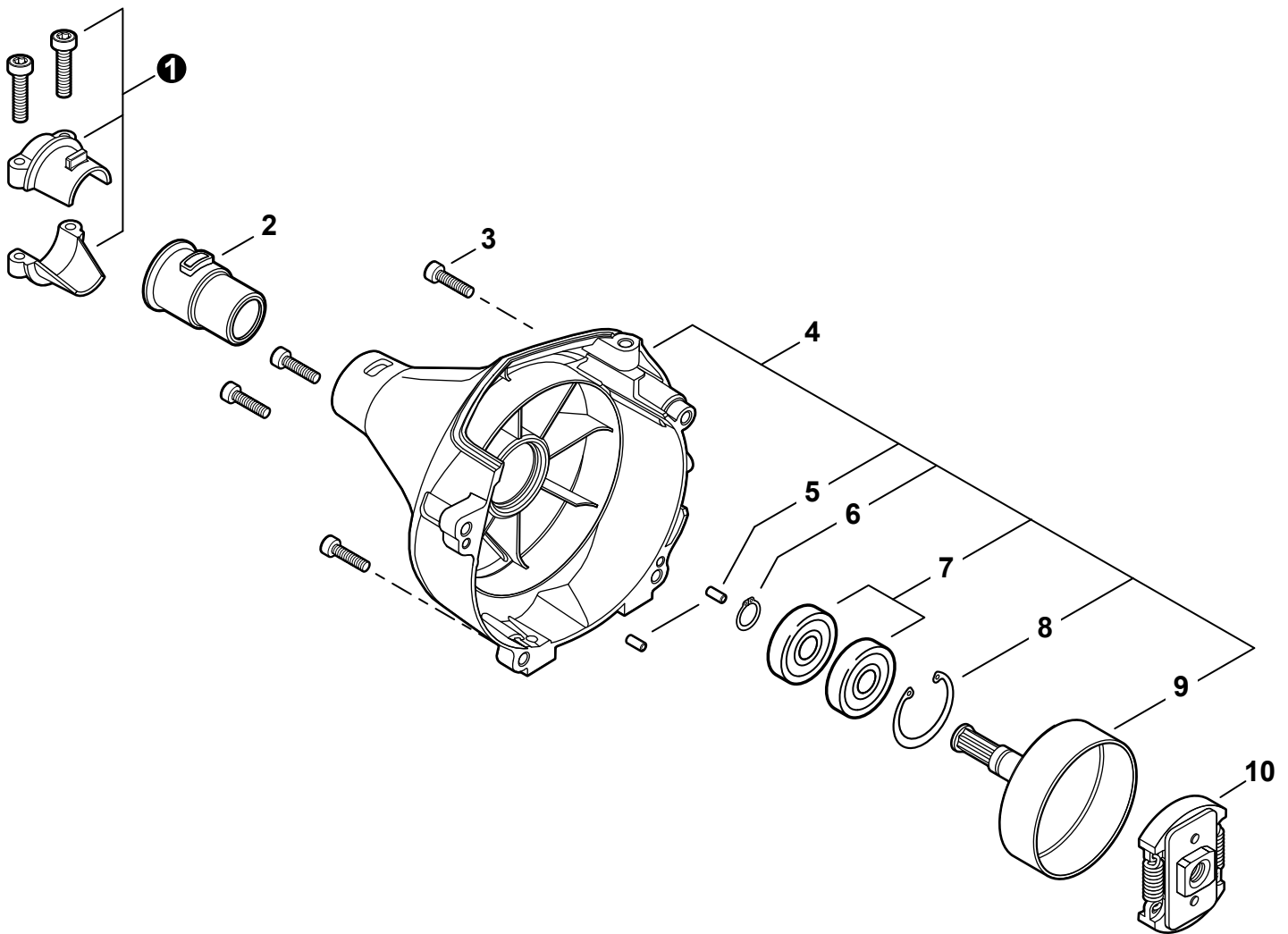

NO.	PART NUMBER	QTY.	DESCRIPTION	DESCRIPCIÓN
1	P021043640	1	HOLDER KIT	JUEGO DE SUJETADOR
2	61091055230	1	CUSHION Ø25	AMORTIGUADOR Ø25
3	V804000060	4	BOLT, TORX 4×16	PERNO TORX 4×16
4	P021015560	1	COVER ASSY, FAN	MONTAJE DE CUBIERTA DEL VENTILADOR
5	V622000020	2	+PIN, LOCATING 4	+PASADOR DE POSICIONAMIENTO 4
6	90070100012	1	+RING, SNAP 12	+ANILLO RETENEDOR 12
7	9405106001	2	+BEARING, BALL 6001	+COJINETE DE BALINES 6001
8	90070200028	1	+RING, SNAP 28	+ANILLO RETENEDOR 28
9	17500548931	1	+DRUM, CLUTCH	+TAMBOR EMBRAGUE
10	A056000240	1	CLUTCH ASSY	MONTAJE DE EMBRAGUE

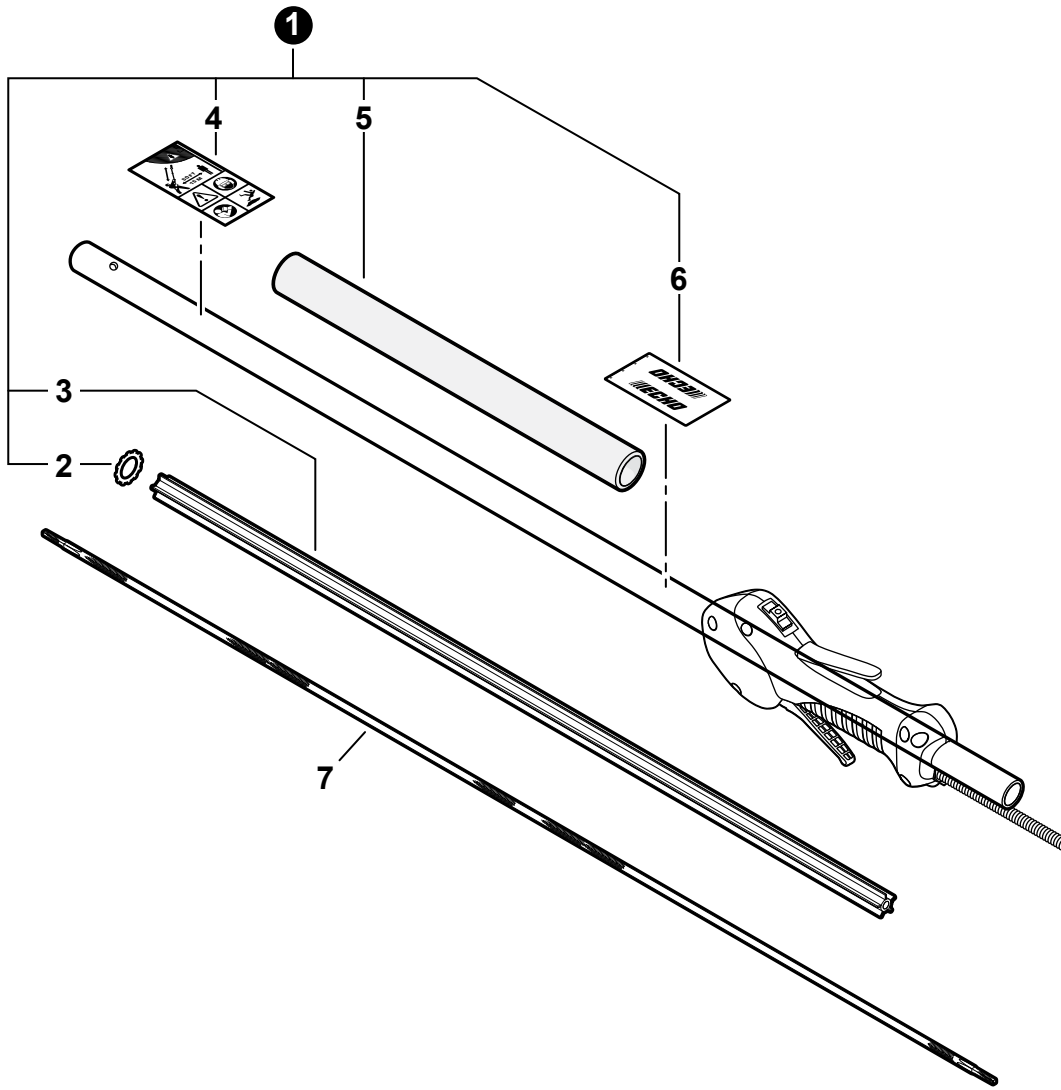

NO.	PART NUMBER	QTY.	DESCRIPTION	DESCRIPCIÓN
1	C050001210	1	MAIN PIPE ASSY	MONTAJE DE TUBO PRINCIPAL
2	90003800100	1	+WASHER	+ARANDELA
3	61021722061	1	+LINER - FLEXIBLE	+FORRO - FLEXIBLE
4	X505001821	1	+LABEL, CAUTION	+ETIQUETA DE PRECAUCIÓN
5	C403000200	1	+GRIP, FRONT	+AGARRE DELANTERO
6	X502000690	1	+LABEL, HANDLE LOCATION	+ETIQUETA - UBICACIÓN DEL MANGO
7	61001322060	1	DRIVESHAFT - FLEXIBLE	EJE DE MANDO - FLEXIBLE

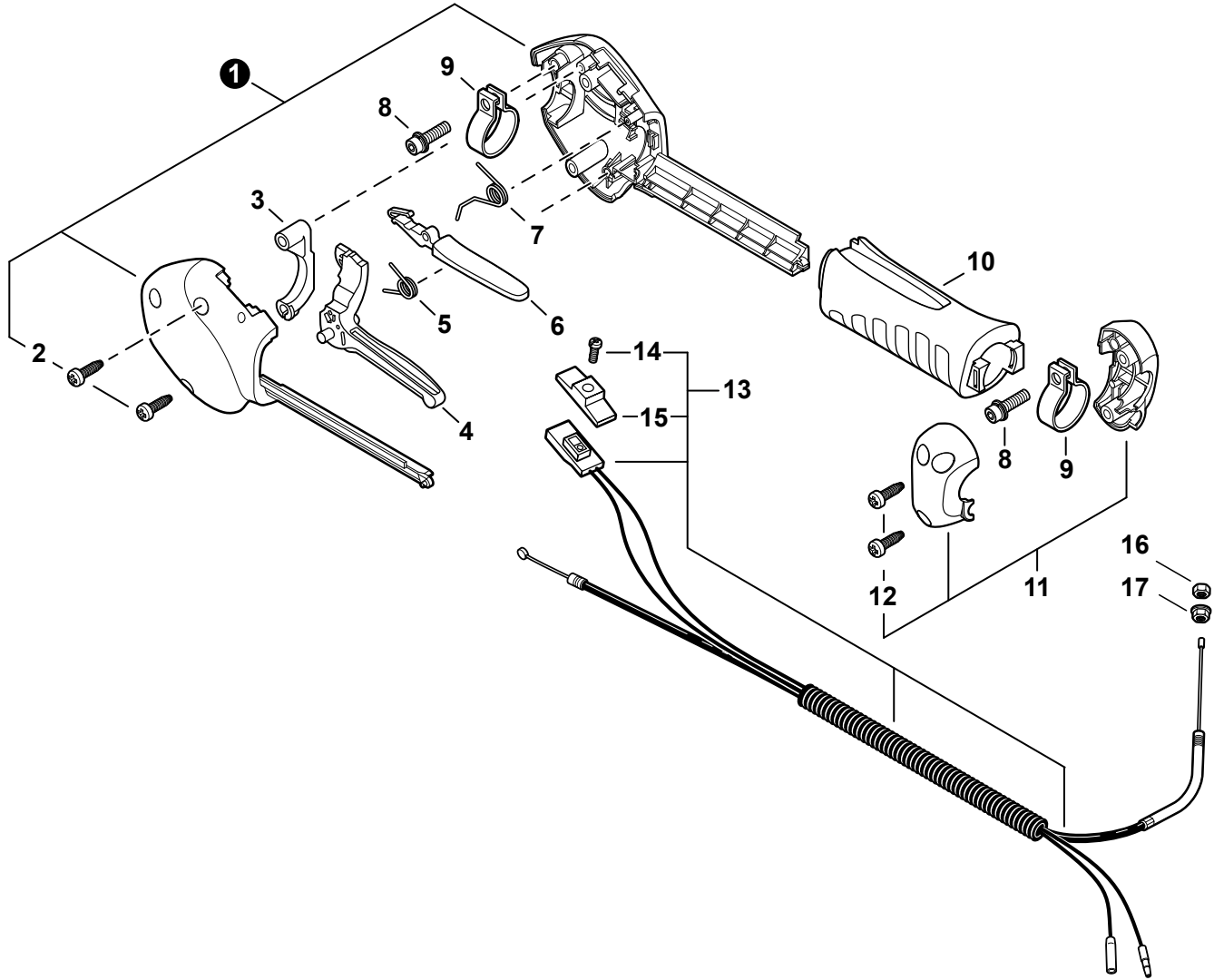

NO.	PART NUMBER	QTY.	DESCRIPTION	DESCRIPCIÓN
1	P021015900	1	HANDLE KIT, CONTROL	JUEGO DE MANGO PARA CONTROL
2	V804000020	2	+BOLT, TORX 4x20	+PERNO TORX 4x20
3	C453000151	1	LOCKOUT, THROTTLE	SEGURO DEL ACELERADOR
4	C450000183	1	TRIGGER, THROTTLE	GATILLO DEL ACELERADOR
5	V452000212	1	SPRING, TORSION	RESORTE DE TORSIÓN
6	C460000051	1	LEVER, THROTTLE LOCKOUT	PALANCA SEGURO DEL ACELERADOR
7	V452000240	1	SPRING, TORSION	RESORTE DE TORSIÓN
8	V805000160	2	BOLT, TORX 5x20	PERNO TORX 5x20
9	V495000680	2	CLAMP	ABRAZADERA
10	C412000090	1	GRIP, HANDLE	AGARRE
11	P021015910	1	FIXTURE SET, HANDLE	JUEGO DE ABRAZADERA DE MANGO
12	V804000020	2	+BOLT, TORX 4x20	+PERNO TORX 4x20
13	P021015650	1	CABLE ASSY, CONTROL	MONTAJE DE CABLE PARA CONTROL
14	9154503010	1	+SCREW 3x10	+TORNILLO 3x10
15	A444000020	1	+KNOB, SWITCH - ORANGE	+BOTÓN DE INTERRUPTOR - NARANJA
16	90050200006	1	NUT M6	TUERCA M6
17	90051800006	1	NUT, FLANGE 6	TUERCA-BRIDA 6

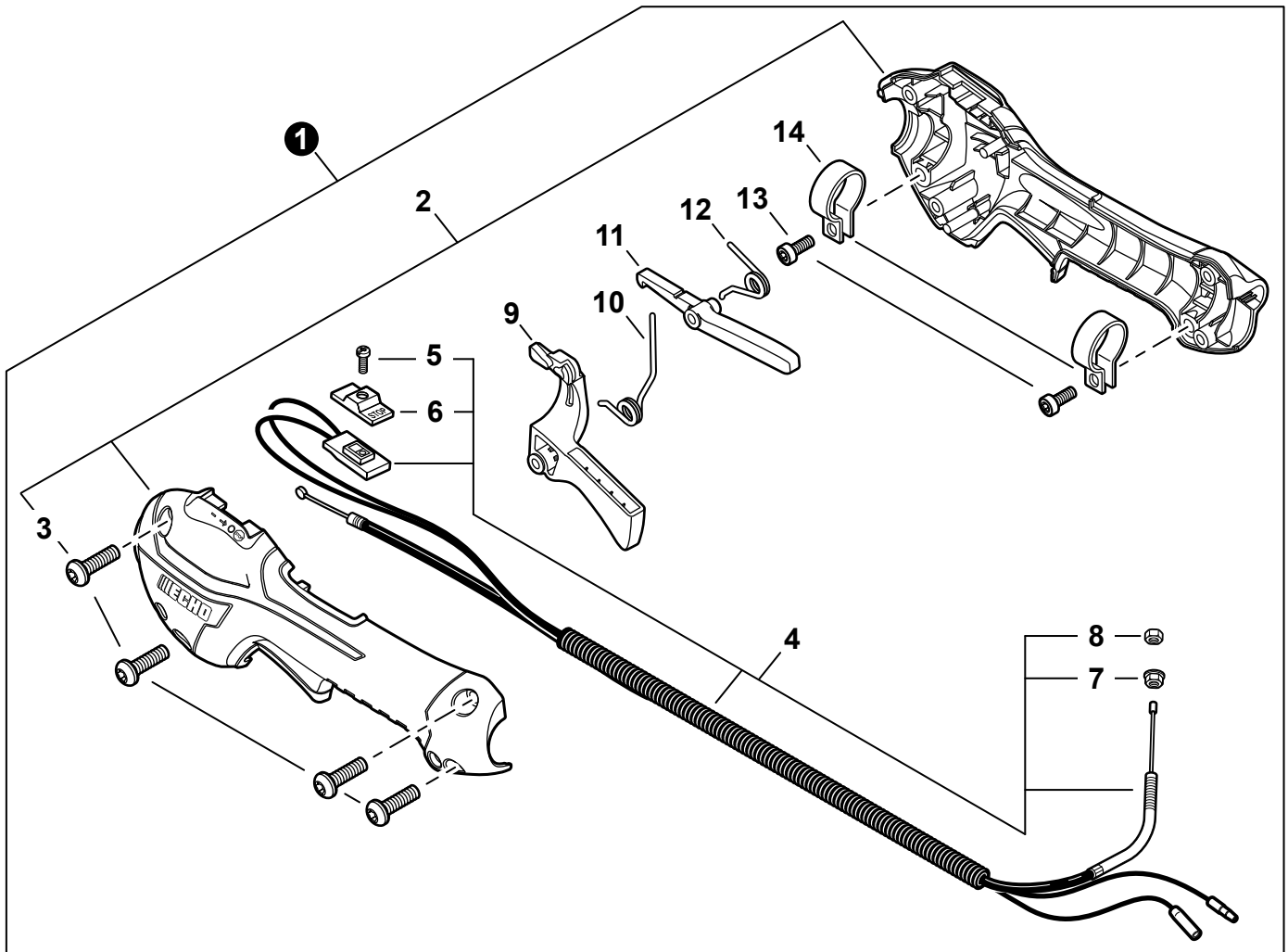

NO.	PART NUMBER	QTY.	DESCRIPTION	DESCRIPCIÓN
1	P021044480	1	CONTROL HANDLE KIT	JUEGO DE MANGO DE CONTROL
2	P021044370	1	+CONTROL HANDLE KIT	+JUEGO DE MANGO DE CONTROL
3	V805000000	4	++BOLT, TORX 5×16	++PERNO TORX 5×16
4	P021044750	1	+CABLE ASSY, CONTROL	+MONTAJE DE CABLE PARA CONTROL
5	9154503010	1	++SCREW 3×10	++TORNILLO 3×10
6	A444000020	1	++KNOB, SWITCH - ORANGE	++BOTÓN DE INTERRUPTOR - NARANJA
7	90051500006	1	++NUT, FLANGE M6×1	++TUERCA-BRIDA M6×1
8	90050200006	1	++NUT M6	++TUERCA M6
9	C453000480	1	+TRIGGER, THROTTLE	+GATILLO DEL ACELERADOR
10	V452001520	1	+SPRING, TORSION	+RESORTE DE TORSIÓN
11	C460000440	1	+LEVER, THROTTLE LOCKOUT	+PALANCA SEGURO DEL ACELERADOR
12	V452001510	1	+SPRING, TORSION	+RESORTE DE TORSIÓN
13	V805000150	2	+BOLT, TORX 5×16	+PERNO TORX 5×16
14	V495003020	1	+CLAMP	+ABRAZADERA

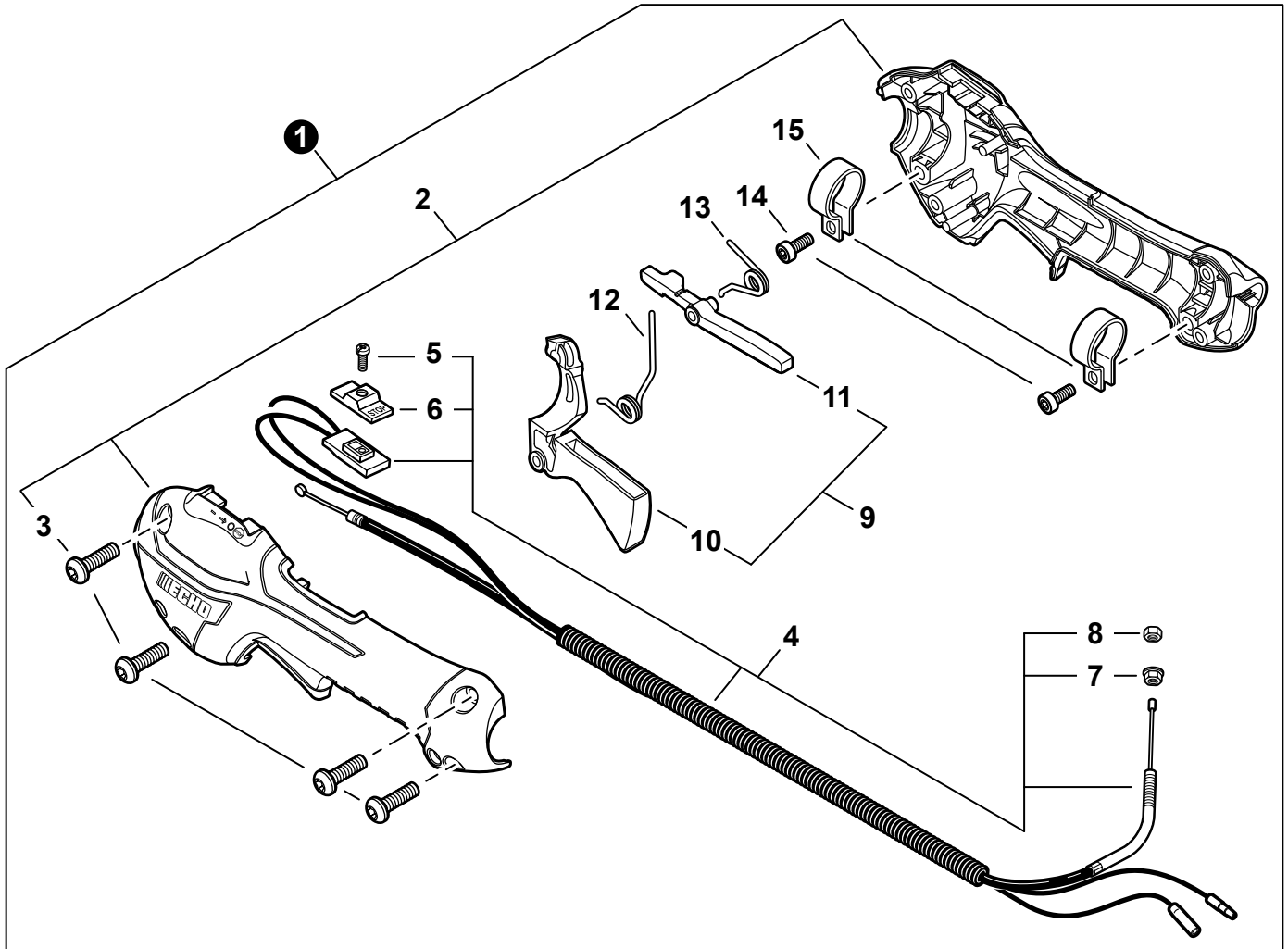

NO.	PART NUMBER	QTY.	DESCRIPTION	DESCRIPCIÓN
1	P021044483	1	CONTROL HANDLE ASSY	MONTAJE DE MANGO DE CONTROL
2	P021044371	1	+CONTROL HANDLE KIT	+JUEGO DE MANGO DE CONTROL
3	V805000000	4	++BOLT, TORX 5×16	++PERNO TORX 5×16
4	P021044750	1	+CABLE ASSY, CONTROL	+MONTAJE DE CABLE PARA CONTROL
5	9154503010	1	++SCREW 3×10	++TORNILLO 3×10
6	A444000020	1	++KNOB, SWITCH - ORANGE	++BOTÓN DE INTERRUPTOR - NARANJA
7	90051800006	1	++NUT, FLANGE 6	++TUERCA-BRIDA 6
8	90050200006	1	++NUT M6	++TUERCA M6
9	P021047440	1	+THROTTLE LOCKOUT KIT	+JUEGO DE SEGURO DEL ACELERADOR
10	C453000482	1	++TRIGGER, THROTTLE	++GATILLO DEL ACELERADOR
11	C460000441	1	++LEVER, THROTTLE LOCKOUT	++PALANCA SEGURO DEL ACELERADOR
12	V452001520	1	+SPRING, TORSION	+RESORTE DE TORSIÓN
13	V452001510	1	+SPRING, TORSION	+RESORTE DE TORSIÓN
14	V805000150	2	+BOLT, TORX 5×16	+PERNO TORX 5×16
15	V495003020	2	+CLAMP	+ABRAZADERA

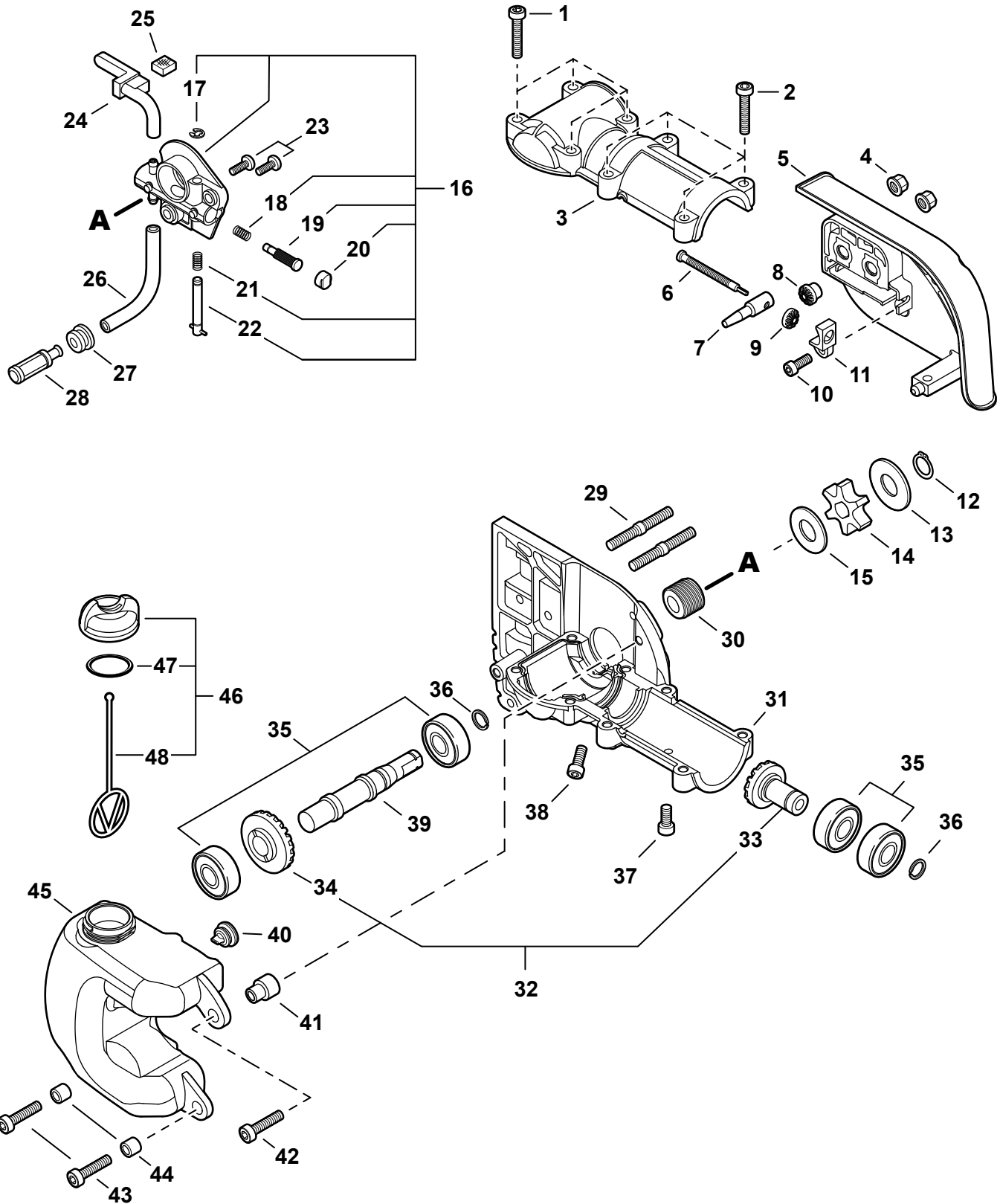

NO.	PART NUMBER	QTY.	DESCRIPTION	DESCRIPCIÓN
1	V805000170	4	BOLT, TORX 5×25	PERNO TORX 5×25
2	V805000170	4	BOLT, TORX 5×25	PERNO TORX 5×25
3	C531000010	1	+CASE, GEAR - UPPER	+CAJA DE ENGRANAJES SUPERIOR
4	43301903933	2	+NUT, FLANGE 6	+TUERCA-BRIDA 6

NO.	PART NUMBER	QTY.	DESCRIPTION	DESCRIPCIÓN
5	C300000920	1	GUARD, SPROCKET	CUBIERTA DEL PIÑÓN
6	V203000041	1	BOLT 5	PERNO 5
7	C309000030	1	TENSIONER, CHAIN	TENSOR DE CADENA
8	V651000320	1	GEAR - 14 TOOTH	ENGRANAJE - 14 DIENTE
9	V651000310	1	GEAR - 14 TOOTH	ENGRANAJE - 14 DIENTE
10	V252000040	1	SCREW 4	TORNILLO 4
11	V355000140	1	COLLAR 8	COLLAR 8
12	V583000090	1	RING, SNAP	ANILLO RETENEDOR
13	V307000160	1	WASHER 10	ARANDELA 10
14	C580000070	1	SPROCKET, DRIVE	RUEDA DENTADA
15	17501439131	1	WASHER 10.2x24.5x1.2	ARANDELA 10.2x24.5x1.2
16	C022000010	1	AUTO-OILER ASSY	MONTAJE DE ENGRASADOR AUTOMÁTICO
17	12532715130	1	+E-RING	+RETENEDOR TIPO "E"
18	P022010660	1	+SPRING	+RESORTE
19	P022010650	1	+PLUNGER ASSY	+MONTAJE DE ÉMBOLO
20	P022010640	1	+CAP, OIL PUMP	+TAPA DE BOMBA DE ACEITE
21	P022010670	1	+SPRING	+RESORTE
22	P022010680	1	+ADJUSTER, OILER	+AJUSTADOR DE ENGRASADOR
23	V805000130	2	BOLT, TORX 5x10	PERNO TORX 5x10
24	V470000180	1	PIPE, OIL OUTLET	TUBO DE SALIDA DE ACEITE
25	43724439130	1	PAD, FOAM	AMORTIGUADOR DE ESPUMA
26	13011012330	1	PIPE, IMPULSE 3x6x70	TUBO DE IMPULSO 3x6x70
27	13211501461	1	GROMMET	OJAL
28	43620502832	1	FILTER, OIL	FILTRO DE ACEITE
29	V224000040	2	BOLT, STUD 6	PERNO PRISIONERO 6
30	43706338330	1	GEAR, WORM	ENGRANAJE DE TORNILLO SIN FIN
31	C531000460	1	CASE, GEAR	CAJA DE ENGRANAJES
32	P021009731	1	GEAR SET	JUEGO DE ENGRANAJES
33	V651000230	1	GEAR, BEVEL	ENGRANAJE CÓNICO
34	V651000201	1	GEAR, BEVEL - 23 TOOTH	ENGRANAJE CÓNICO - 23 DIENTE
35	9404206001	4	BEARING, BALL	COJINETE DE BALINES
36	90070600012	2	RING, SNAP Ø12	ANILLO RETENEDOR Ø12
37	V805000130	1	BOLT, TORX 5x10	PERNO TORX 5x10
38	V805000130	1	BOLT, TORX 5x10	PERNO TORX 5x10
39	C534000430	1	SHAFT, GEAR	EJE DE ENGRANAJE
40	13131406320	1	VENT ASSY	VÁLVULA DE RESPIRADERO
41	V354000010	1	COLLAR 6	COLLAR 6
42	V805000170	1	BOLT, TORX 5x25	PERNO TORX 5x25
43	V805000160	2	BOLT, TORX 5x20	PERNO TORX 5x20
44	13104528230	2	SPACER 6.2x7.8x6	ESPACIADOR 6.2x7.8x6
45	C200000081	1	TANK, OIL	TANQUE DE ACEITE
46	P021005592	1	CAP ASSY	MONTAJE DE TAPA
47	90072000018	1	+O-RING 18	+JUNTA TÓRICA 18
48	A365000050	1	+CONNECTOR, CAP L= 60mm	+CONECTOR DE TAPA L= 60mm

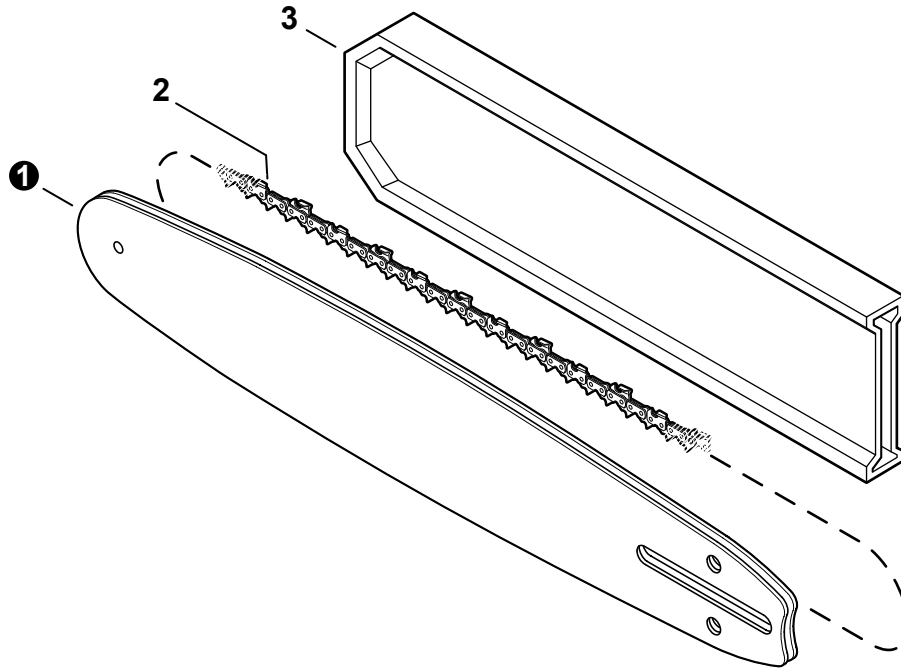

NO.	PART NUMBER	QTY.	DESCRIPTION	DESCRIPCIÓN
1	10A0CD3739	1	GUIDE BAR, 10"	BARRA GUÍA 25cm
1	10A4CD3739	1	GUIDE BAR, 10"	BARRA GUÍA 25cm
1	12A0CD3744	1	GUIDE BAR, 12"	BARRA GUÍA 30 cm
1	12A4CD3744	1	GUIDE BAR, 12"	BARRA GUÍA 30 cm
2	91VXL39CQ	1	SAW CHAIN 10" 0.050" GA	CADENA 25cm 0.050" GA
2	90PX39CQ	1	SAW CHAIN 10" 0.043" GA	CADENA 25cm 0.043" GA
2	91VXL44CQ	1	SAW CHAIN 12" 0.050" GA	CADENA 30cm 0.050" GA
2	90PX44CQ	1	SAW CHAIN 12" 0.043" GA	CADENA 30cm 0.043" GA
3	X490000050	1	SCABBARD 12"	FUNDA 30cm
3	X490000060	1	SCABBARD 10"	FUNDA 25cm

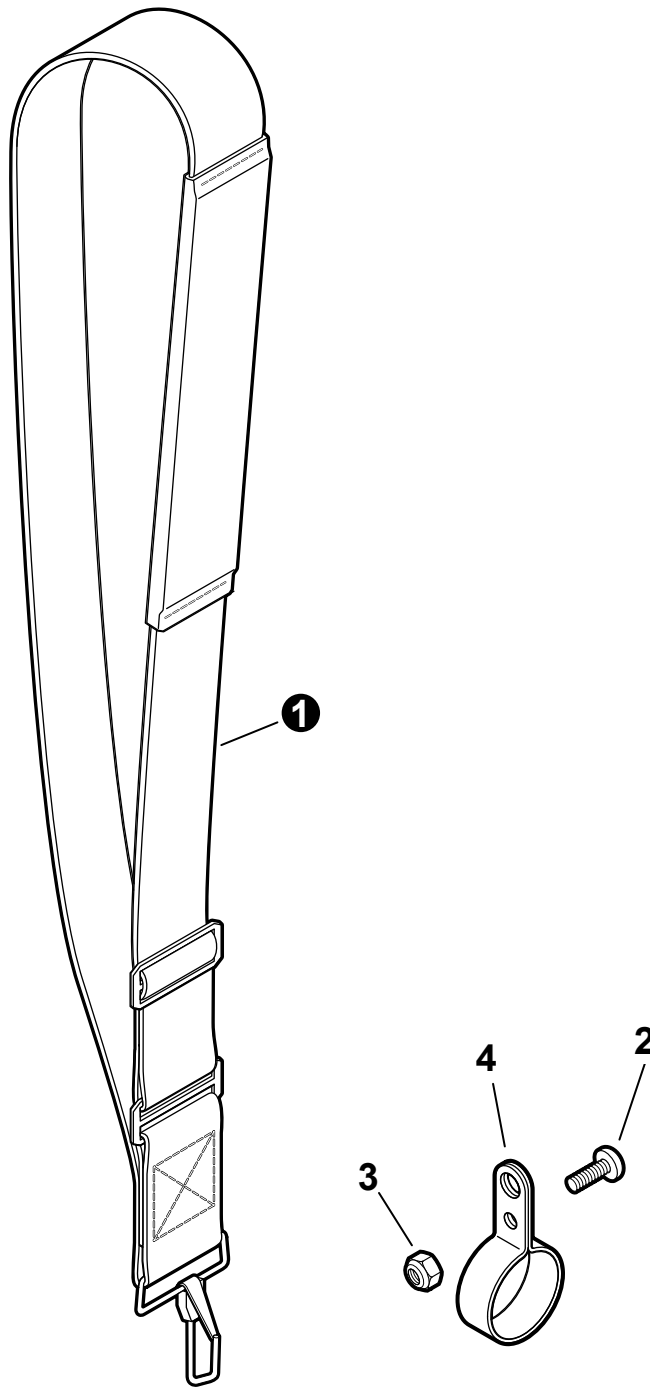

NO.	PART NUMBER	QTY.	DESCRIPTION	DESCRIPCIÓN
1	30100022060	1	STRAP ASSY, SHOULDER	MONTAJE DE CORREA DE HOMBRO
2	V805000130	1	BOLT, TORX 5×10	PERNO TORX 5×10
3	90056000005	1	NUT, LOCK M5	CONTRATUERCA M5
4	30061022061	1	CLAMP	ABRAZADERA

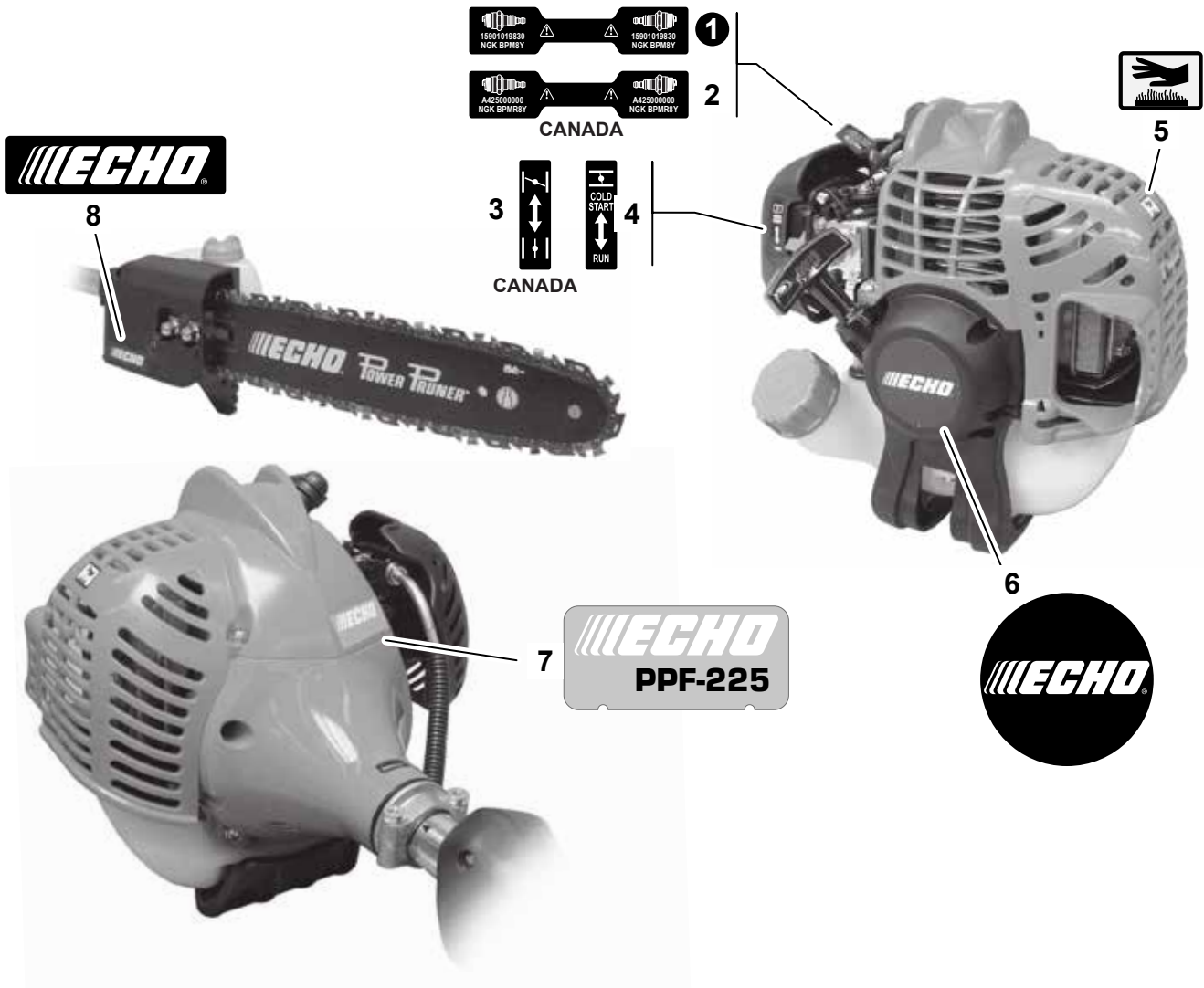

NO.	PART NUMBER	QTY.	DESCRIPTION	DESCRIPCIÓN
1	X532000671	1	LABEL, SPARK PLUG - BPM8Y	ETIQUETA DE BUJÍA BPM8Y
2	X532000720	1	LABEL, SPARK PLUG - BPMR8Y	ETIQUETA DE BUJÍA BPMR8Y
3	89033252730	1	LABEL, CHOKE	ETIQUETA DEL ESTRANGULADOR
4	89012152730	1	LABEL, CHOKE	ETIQUETA DEL ESTRANGULADOR
5	X505002310	1	LABEL, CAUTION - HOT	ETIQUETA DE PRECAUCIÓN CALIENTE
6	X502000330	1	LABEL, ECHO	ETIQUETA ECHO
7	X547001350	1	LABEL, MODEL	ETIQUETA MODELO
8	X502000600	1	LABEL, ECHO	ETIQUETA ECHO

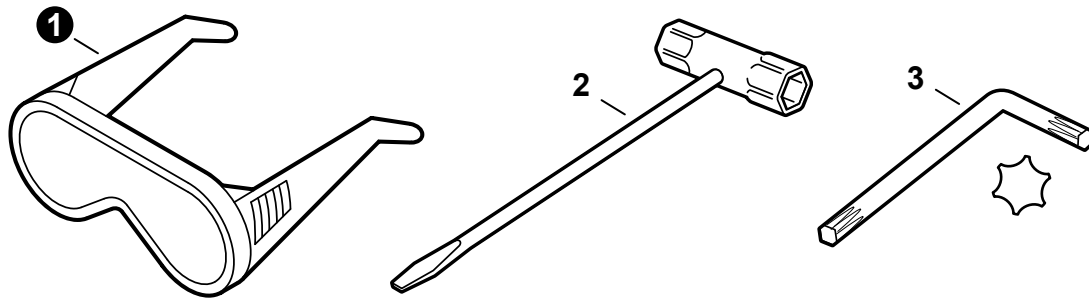

NO.	PART NUMBER	QTY.	DESCRIPTION	DESCRIPCIÓN
1	89541039131	1	T-WRENCH 10×19mm	LLAVE EN T 10×19mm
2	X605000060	1	WRENCH, ALLEN T27 80×30	LLAVE ALLEN T27 80×30
3	X690000080	1	GLASSES, SAFETY	ANTEOJOS DE SEGURIDAD

NO.	PART NUMBER	QTY.	DESCRIPTION	DESCRIPCIÓN
1	P021015981	1	GASKET KIT	JUEGO DE EMPAQUETADURA
2	10024242030	1	+GASKET, CRANKCASE	+EMPAQUETADURA DE CÁRTER
3	V100000160	1	+GASKET, CYLINDER	+EMPAQUETADURA DE CILINDRO
4	V103001500	1	+GASKET, INTAKE	+EMPAQUETADURA DE ADMISIÓN
5	V103001360	1	+GASKET, INTAKE	+EMPAQUETADURA DE ADMISIÓN
6	V104000850	1	+GASKET, EXHAUST	+EMPAQUETADURA DE ESCAPE
7	V104001760	1	+GASKET, EXHAUST	+EMPAQUETADURA DE ESCAPE
8	90139BP	1	FUEL SYSTEM KIT - REPOWER	KIT DEL SISTEMA DE COMBUSTIBLE - REPOWER
9	A356000031	1	+VENT ASSY	+VÁLVULA DE RESPIRADERO
10	13120507321	1	+FILTER, FUEL	+FILTRO DE COMBUSTIBLE
11	13211546730	1	+GROMMET, FUEL Ø5	+OJAL DE COMBUSTIBLE Ø5
12	V186000520	1	+CONNECTOR, PIPE Ø5×Ø3.5	+CONECTOR DE TUBO Ø5×Ø3.5
13	V470001960	1	+PIPE, FUEL 3×5×110 BLACK	+TUBO DE COMBUSTIBLE 3×5×110 NEGRO
14	13201256030	1	+PIPE, FUEL 3×6×80 CLEAR	+TUBO DE COMBUSTIBLE 3×6×80 TRANSPARENTE
15	V471003691	1	+PIPE, FUEL 3×5×74 BLACK	+TUBO DE COMBUSTIBLE 3×5×74 NEGRO
16	V471001210	1	+PIPE, FUEL 3×5×90 BLACK	+TUBO DE COMBUSTIBLE 3×5×90 NEGRO
17	V490001240	3	+CLIP Ø6	+SUJETADOR Ø6
18	90152	1	TUNE-UP KIT - REPOWER	JUEGO DE PUESTA A PUNTO - REPOWER
19	A369000480	1	+FILTER, FUEL	+FILTRO DE COMBUSTIBLE
20	A226001410	1	+FILTER, AIR - DOUBLE LAYER	+FILTRO DE AIRE - CAPA DOBLE
21	A425000000	1	+SPARK PLUG - BPMR8Y	+BUJÍA BPMR8Y
22	99944440000	1	ROPE, STARTER - REPOWER BULK Ø3	CUERDA DEL ARRANCADOR REPOWER AL POR MAYOR
23	90014	1	PIPE, BULK - REPOWER 3×5mm BLACK	TUBO REPOWER AL POR MAYOR 3×5mm NEGRO
24	90017	1	PIPE, BULK - REPOWER 3×6mm CLEAR	TUBO REPOWER AL POR MAYOR 3×6mm TRANSPARENTE
25	90248	1	CAP/VENT KIT - REPOWER	JUEGO DE TAPA Y RESPIRADERO - REPOWER
26		1	+CAP, FUEL	+TAPA DE COMBUSTIBLE
27	A356000031	1	+VENT ASSY	+VÁLVULA DE RESPIRADERO
28	V107000150	1	+GASKET, FUEL CAP	+EMPAQUETADURA DEL TAPA DE COMBUSTIBLE
29	90008	1	FILTER KIT - REPOWER	JUEGO DE FILTRO - REPOWER
30	A226001410	1	+FILTER, AIR - DOUBLE LAYER	+FILTRO DE AIRE - CAPA DOBLE
31	13120507321	1	+FILTER, FUEL	+FILTRO DE COMBUSTIBLE
32	90117	1	FUEL SYSTEM KIT - REPOWER	KIT DEL SISTEMA DE COMBUSTIBLE - REPOWER
33	13101655830	1	+GASKET, FUEL CAP	+EMPAQUETADURA DEL TAPA DE COMBUSTIBLE
34	A356000031	1	+VENT ASSY	+VÁLVULA DE RESPIRADERO
35	13120507321	1	+FILTER, FUEL	+FILTRO DE COMBUSTIBLE
36	13211546730	1	+GROMMET, FUEL Ø5	+OJAL DE COMBUSTIBLE Ø5
37	13201256030	1	+PIPE, FUEL 3×6×80 CLEAR	+TUBO DE COMBUSTIBLE 3×6×80 TRANSPARENTE
38	V471001210	1	+PIPE, FUEL 3×5×90 BLACK	+TUBO DE COMBUSTIBLE 3×5×90 NEGRO
39	V490001240	2	+CLIP Ø6	+SUJETADOR Ø6