



PR400™

**Commercial Series
Two-Way Radio User Guide
Manuel de l'utilisateur
de la radio bidirectionnelle**

COMPUTER SOFTWARE COPYRIGHTS

The Motorola products described in this manual may include copyrighted Motorola computer programs stored in semiconductor memories or other media. Laws in the United States and other countries preserve for Motorola certain exclusive rights for copyrighted computer programs including, but not limited to, the exclusive right to copy or reproduce in any form the copyrighted computer program. Accordingly, any copyrighted Motorola computer programs contained in the Motorola products described in this manual may not be copied, reproduced, modified, reverse-engineered, or distributed in any manner without the express written permission of Motorola. Furthermore, the purchase of Motorola products shall not be deemed to grant either directly or by implication, estoppel, or otherwise, any license under the copyrights, patents or patent applications of Motorola, except for the normal non-exclusive license to use that arises by operation of law in the sale of a product.

CONTENTS

Computer Software Copyrights . . . inside cover		Wall Charger	16
Safety	5	Desktop Chargers	16
Product Safety and RF Exposure		Rapid Charger	16
Compliance	5	Slow Charger	17
Introduction	7	Battery Charge Status	18
Conventional Radio Systems	7	LED Indicator	18
Trunked Radio Systems	7	Display	19
LTR Trunked Systems	7	DTMF Keypad	20
PR400 Radio Features	8	Indicator Tones	21
Radio-Wide Features	8	Programmable Buttons	22
LTR Trunked Features	8	Menu Buttons	26
Conventional Signaling Features	8	Menu Button	26
Radio Overview	11	Menu Scroll Buttons	26
Accessory Information	12	Navigate the Menu	26
Attach the Battery	12	Exit the Menu	26
Remove the Battery	12	Getting Started	27
Attach the Antenna	13	Turn the Radio On or Off	27
Remove the Antenna	13	Adjust the Volume	27
Attach the Belt Clip	14	Select an LTR Channel/Talkgroup	28
Remove the Belt Clip	14	Select a Conventional Radio Channel	28
Battery Information	15	Receive a Conventional or LTR Call	28
Charging Your Battery	15	Monitor	29
		Permanent Monitor	29
		Transmit an LTR Call	30
		Transmit a Conventional Call	30
		Call Light (Trunked Operation Only)	31

Repeater or Talkaround Mode	31	Scan	39
Revert Memory Channel (1 & 2)	32	Talkback	39
Store Memory Channel (1 & 2)	32	Start System Scan	39
Home Revert AutoKey (1 & 2)	32	Stop System Scan	40
VOX Operation	32	Start Auto Scan	40
Connecting a VOX Headset	32	Stop Auto Scan	40
Enable or Disable VOX	32	Delete a Nuisance Channel/Talkgroup	41
Enable/Disable Headset Sidetone	33	Restore Channels/Talkgroups to the	
VOX Headset	33	Scan List	41
Non-VOX Headset with In-Line PTT	33	Edit a Scan List	42
Keypad Lock/Unlock	34	Add or Delete Channels/Talkgroups in a	
Program PL/DPL Codes	34	Scan List	42
Radio Calls	35	Prioritize a Channel or Talkgroup in a	
Selective Radio Inhibit	35	Scan List	43
Receive a Selective Call		Phone	45
(Conventional Operation Only)	35	Access the Repeater	45
Send a Selective Call		Receive a Phone Call	45
(Conventional Operation Only)	35	Disconnect a Phone Call	46
Receive a Call Alert™ Page		Make a Phone Call	46
(Conventional Operation Only)	36	Edit the Phone List	48
Send a Call Alert Page		Add an Entry	48
(Conventional Operation Only)	36	Delete an Entry	49
Repeater Access	37	Edit an Entry	49
Radio Check	37	Edit Access/Deaccess Codes	50

Tone Preferences	51
Tones On/Off.	53
Keypad On/Off Tones	53
Call Tone Tagging (Conventional Operation Only).	54
Escalart (Conventional Operation Only).	54
User Settings	55
Set Squelch Level	57
Set Power Level	57
Option Board On/Off	58
Set the Lights	58
Display the Software Version	59
Warranty	61
Accessories	65
Antennas	65
Batteries	65
Carry Accessories	65
Chargers	66
Headsets	66
Surveillance Accessories	67
Ear Microphone Systems	68
Remote Speaker Microphones	68
Miscellaneous	68

Notes:

SAFETY

PRODUCT SAFETY AND RF EXPOSURE COMPLIANCE



Before using this product, read the operating instructions for safe usage contained in the Product Safety and RF Exposure booklet enclosed with your radio.

ATTENTION!

This radio is restricted to occupational use only to satisfy FCC RF energy exposure requirements. Before using this product, read the RF energy awareness information and operating instructions in the Product Safety and RF Exposure booklet enclosed with your radio (Motorola Publication part number 68P81095C98) to ensure compliance with RF energy exposure limits.

For a list of Motorola-approved antennas, batteries, and other accessories, visit the following web site which lists approved accessories: <http://www.motorola.com/cgiss/index.shtml>.

Notes:

INTRODUCTION

Your PR400™ radio can operate on both LTR® trunked and conventional radio systems. This radio combines the very latest in two-way technology while delivering outstanding functionality at the touch of a button.

CONVENTIONAL RADIO SYSTEMS

Conventional typically refers to radio-to-radio communications through a single channel. Conventional systems also allow radio users to extend communication coverage by relaying their messages through a repeater. To ensure coordinated use by multiple users, each radio user must monitor the channel or repeater before transmitting to verify that the system is not currently busy.

TRUNKED RADIO SYSTEMS

A trunked radio system allows a large number of users to share a relatively small number of frequencies or repeaters without interfering with each other. The airtime of all the repeaters in a trunked system is pooled, which maximizes the amount of airtime available to

any one radio and minimizes channel/talkgroup congestion.

Some of the benefits of trunked two-way radio systems are:

- No channel/talkgroup monitoring required prior to transmission
- Improved system access
- Automatic channel/talkgroup selection
- Increased privacy among members of the same group

LTR Trunked Systems

LTR (Logic Trunked Radio) is a transmission-based trunking protocol developed by the E. F. Johnson Company for primarily single-site trunking applications. In transmission trunking, a repeater is used for only the duration of a single transmission. Once a transmission is completed, that repeater becomes available to other users. This means that a conversation comprised of many transmissions may occur over several different channels/talkgroups within the LTR system. This method of trunking provides system efficiency by making repeaters available to all users after every transmission.

When an LTR trunked radio user wants to communicate with another radio, the user's

radio sends a “channel/talkgroup request” to the home repeater. The system then sends back a “channel/talkgroup grant” to the user’s radio. The channel/talkgroup grant message contains the number of a “go to” repeater to tell the radio which repeater to use. This “go to” repeater can be the same as the radio’s home repeater or another repeater in the system.

The radio uses the “go to” repeater for transmission. Once the transmission has ended, this repeater is available for other users.

PR400 RADIO FEATURES

Radio-Wide Features

- 64 Conventional Channels
- Up to 10 Sites and 100 Talkgroups
- Up to 20 Repeaters per Site
- 8-Character Alphanumeric Display
- 4 Programmable Feature Buttons
- 2 Memory Channels
- Telephone Interconnect
- User-programmable Phone, Scan, and TPL/DPL Lists
- Option Board Expandability
- Busy Channel Lockout
- High/Low Power Settings

- Transmit Time-Out Timer
- Monitor and Sticky Permanent Monitor
- System Scan with 2 Priority Levels and Revert Scan

LTR Trunked Features

- MDC 1200 Signaling

- Selective Radio Inhibit Decode	- MDC Pre-Time
- Radio Check Decode	- PTT ID Encode/Decode
	- DOS

Conventional Signaling Features

- MDC 1200 Signaling

- Selective Radio Inhibit Decode	- PTT ID Encode/Decode
----------------------------------	------------------------

- Quik-Call II Signaling

- Call Alert Encode/Decode	- Radio Call List
- Selective Call Encode/Decode	- Call Tone Tagging

- DTMF Signaling

- DTMF PTT ID Encode - DTMF Call Alert Encode	- DTMF Selective Call Encode
--	------------------------------

Notes:

RADIO OVERVIEW

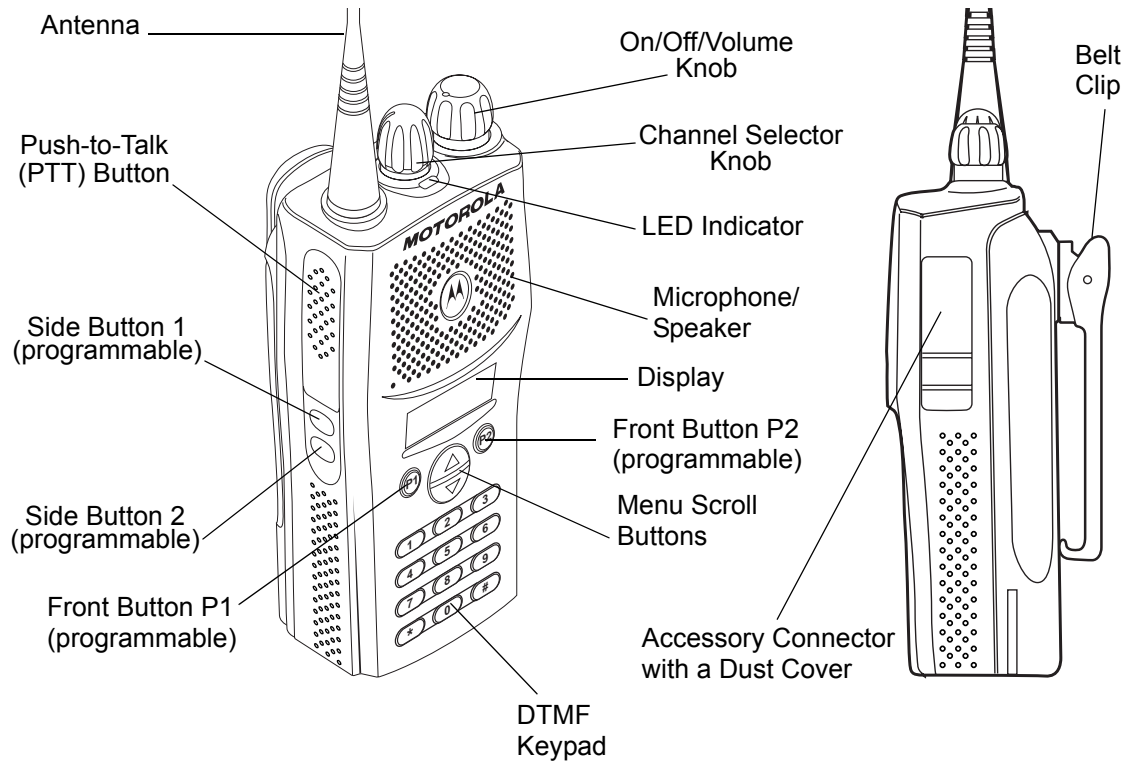

ACCESSORY INFORMATION

Attach the Battery

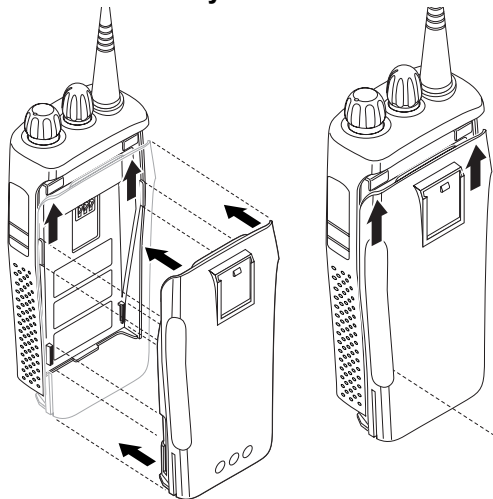

- 1 Align the battery to the battery rails on the back of the radio (approximately 1/2 in. from the top of the radio.)
- 2 Press the battery firmly to the radio and slide the battery upward until the latch snaps into place.
- 3 Slide the battery latch, located on radio bottom, into the lock position.

Remove the Battery

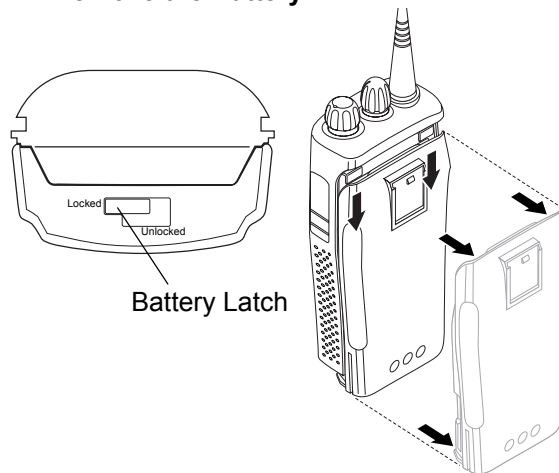

- 1 Turn off the radio if it is turned on (see page 27).
- 2 Slide the battery latch into the unlock position. Disengage by pushing downward and holding the latch towards the front of the radio.
- 3 With the battery latch disengaged, slide the battery down from the top of the radio about 1/2 in. Once the battery is free from the battery rails, lift it directly away from the radio.

Attach the Antenna

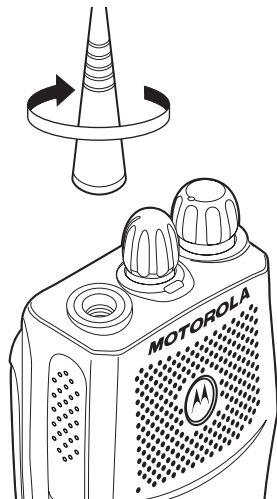

Turn the antenna clockwise to attach it.

Remove the Antenna

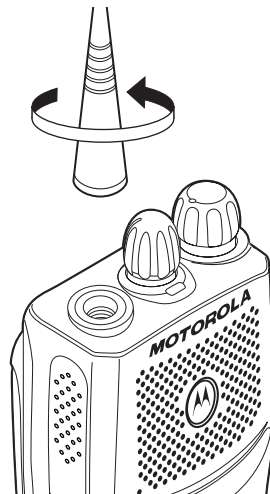

Turn the antenna counter-clockwise to remove it.

Attach the Belt Clip

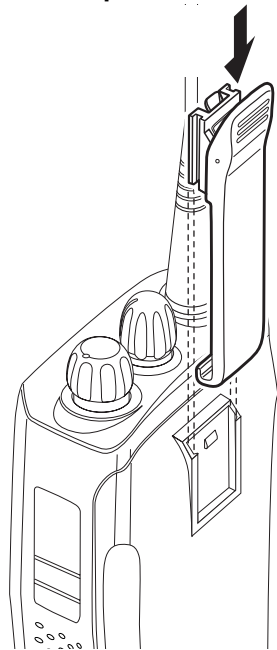

- 1 Align the grooves of the belt clip with those of the battery.
 - 2 Press the belt clip downward until you hear a click.
-

Remove the Belt Clip

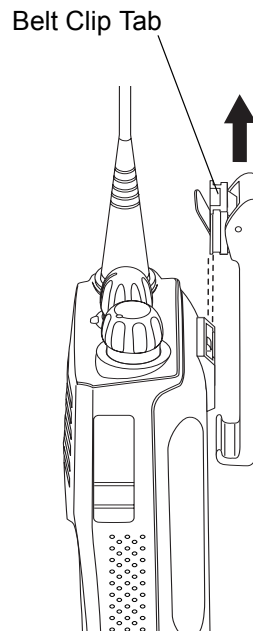

- 1 Use a key to press the belt clip tab away from the battery to unlock the belt clip.
 - 2 Slide the belt clip upward to remove it.
-

BATTERY INFORMATION

Charging Your Battery

This radio is powered by a nickel-cadmium (NiCd), a nickel-metal hydride (NiMH), or a lithium-ion (Li-Ion) rechargeable battery. Charge the battery before use to ensure optimum capacity and performance. The battery was designed specifically to be used with a Motorola charger. Charging in non-Motorola equipment may lead to battery damage and void the battery warranty.

Note: When charging a battery attached to a radio, turn the radio off to ensure a full charge.

The battery should be at about 77°F (25°C) (room temperature), whenever possible. Charging a cold battery (below 50° F [10°C]) may result in leakage of electrolyte and ultimately in failure of the battery. Charging a hot battery (above 95°F [35°C]) results in reduced discharge capacity, affecting the performance of the radio. Motorola rapid-rate battery chargers contain a temperature-sensing circuit to ensure that batteries are charged within the temperature limits stated above.

If a battery is new, or its charge level is very low, you will need to charge it before you can use it. When the battery level is low and the radio is in transmit mode you will see the LED indicator flash red. Upon release of the PTT button, you will hear an alert tone.

Note: Batteries are shipped uncharged from the factory. Always charge a new battery 14 to 16 hours before initial use, regardless of the status indicated by the charger.

Note: Do not use the wall charger and desktop charger at the same time when charging.

WALL CHARGER

Note: Do not use the wall charger if using lithium-ion (Li-Ion) or nickel-metal hydride (NiMH) batteries. The wall charger is for a nickel-cadmium (NiCd) battery only.

To Charge the Battery:

- 1 Turn the radio off.
- 2 Lift the dust cover to expose the audio accessory connector.
- 3 Insert the charging adapter into the accessory connector.
- 4 Plug the charging adapter into an electrical outlet.
 - The LED on the charging adapter lights Red while the charger is plugged into an electrical outlet.

Note: Do not leave the charger connected to the radio when it is not connected to the electrical outlet.

- 5 Unplug the charger from the electrical outlet and radio after 10 hours.

Note: After the initial charge of 14 to 16 hours, do not charge the battery more than 10 hours.

DESKTOP CHARGERS

Rapid Charger

- 1 Turn the radio off.
- 2 Place the battery, with or without the radio, in the charger pocket.
 - The charger LED indicates the charging progress.

LED color	Status
No LED Indication	Battery inserted incorrectly or battery not detected.
Single Green Flash	Successful charger power-up.
Flashing Red ^a	Battery unchargeable or not making proper contact.
Steady Red	Battery is in Rapid charge mode.

LED color	Status
Flashing Yellow	Battery in charger but waiting to be charged. The battery temperature may be too hot or too cold. The voltage may be lower than the pre-determined threshold level for charging.
Flashing Green ^b	Battery 90% (or more) charged. Trickle charging.
Green	Battery fully charged.

- a. Remove the battery from the charger and use a pencil eraser to clean the three metal contacts at the back of the battery. Place the battery back into the charger. If the LED indicator continues to flash red, replace the battery.
- b. A standard battery may require 90 minutes to charge to 90% capacity. Even though new batteries might prematurely indicate a full charge (steady green LED), charge the battery for 14 to 16 hours prior to initial use for best performance.

A list of Motorola authorized batteries and battery chargers appears on page 66. The listed chargers will charge only Motorola

authorized batteries. Other batteries may not charge.

Slow Charger





Note: Do not use the slow charger if using lithium-ion (Li-Ion) or nickel-metal hydride (NiMH) batteries. The slow charger is for a nickel-cadmium (NiCd) battery only.

- 1 Turn the radio off.
- 2 Place the battery, with or without the radio, in the charger pocket.
 - The charger LED indicates the charging progress.

LED color	Status
No LED Indication	Battery inserted incorrectly or battery not detected.
Steady Red	Battery is in over night charge mode. The battery is fully charged after 11 hours.

BATTERY CHARGE STATUS

You can check battery charge status if your dealer has preprogrammed one of the programmable buttons. Hold down the preprogrammed **Battery Indicator** button. The charge status is shown on the display.

Battery Level	Display
Full	
Good	
Fair	
Low	
Very Low	

LED INDICATOR





Indicates power-up, transmit, receive, scan monitor status, channel/talkgroup busy, Call Alert™ receive/transmit, Selective Call receive/transmit, and battery status.







LED State/Color	Indication
Radio Call	
Red	Transmitting
Flashing Red	Receiving
Flashing Red	Channel/Talkgroup Busy
Scan	
Flashing Green	Scanning for activity
Call Alert	
Flashing Yellow	Indicates receiving a Call Alert
Yellow	Indicates sending a Call Alert
Selective Call	
Flashing Yellow	Indicates receiving a Selective Call
Yellow	Indicates sending a Selective Call
Monitor/Open Squelch	
Yellow	While monitoring
Low Battery	
Flashing Red when transmitting	Low battery level

DISPLAY



The top display row displays menu and radio status information:

Symbol	Indication
 Signal Strength	The more bars, the stronger the signal being received by your radio.
 Power Level	Low Power “L” or High Power “H” is activated.
 Monitor	The selected channel is being monitored
 Phone	Phone mode is selected.
 Scan	Indicates that the Scan feature has been activated.

Symbol	Indication
 •Priority 1 Scan (• flashing)	Indicates scan has stopped on an active Priority 1 channel/talkgroup.
 Priority 2 Scan (• steady)	Indicates scan has stopped on an active Priority 2 channel/talkgroup.
 Talkaround	Bypass the repeater and talk directly to another radio.
 Call Received	A Selective Call or Call Alert has been received.
 P	Not Used
 Keypad Lock	The keypad has been locked.
 Option Board	An Option Board has been activated.

DTMF KEYPAD



The keypad is used for:







- Dialing a phone number.
- Entering information when programming phone lists.
- Accessing a repeater.
- Each key can generate several different characters. For example, to enter the character “C,” press the **2 abc** button three times. (Refer to the following table.)

Entering Characters Using the DTMF Keypad

Number of Times Button is Pressed					
Button	1	2	3	4	5
0	0				
1	1	/	\		
2 abc	A	B	C	2	
3 def	D	E	F	3	
4 ghi	G	H	I	4	
5 jkl	J	K	L	5	
6 mno	M	N	O	6	
7 pqrs	P	Q	R	S	7
8 tuv	T	U	V	8	
9 wxyz	W	X	Y	Z	9
*	*	<	>		
#	#	+	-	-	

INDICATOR TONES

High pitched tone  Low pitched tone 

	Self Test Pass Tone
	Self Test Fail Tone
	Positive Indicator Tone
	Negative Indicator Tone
	Good Key Tone
	Bad Key Tone

Some programmable buttons use tones to indicate one of two modes:

Programmable Buttons	Positive Indicator Tone	Negative Indicator Tone
Scan	Start	Stop
Power Level	High	Low
Squelch	Tight	Normal
Repeater/ Talkaround	Does not use repeater	Uses repeater
VOX	Enabled	Disabled
Silent Monitor/ Open Squelch	—	Enabled
Revert Memory Channel (1&2)	—	Enabled
Store Memory Channel (1&2)	—	Stored
Home Revert AutoKey (1&2)	—	Enabled
Menu Mode (P2)	—	Accessed
Radio Call	—	Enabled
Scan List Edit	—	Enabled
Speed Dial	—	Enabled
Phone Mode	—	Enabled
Option Board	Enabled	Disabled
Escalart	Enabled	Disabled

PROGRAMMABLE BUTTONS

Your radio has four programmable buttons. Your dealer can program these buttons as shortcuts to various radio features.

Check with your dealer for a complete list of functions your radio supports.

Programmable buttons include:

- The two side buttons (S1 and S2)
- The two front buttons (P1 and P2)

Some buttons can access up to two features, depending on the type of button press:

- **Short Press** — quickly pressing and releasing the programmable buttons.
- **Long Press** — pressing and holding the programmable buttons for a minimum of 2.5 seconds.
- **Hold Down** — pressing and holding down the programmable buttons while checking status or making adjustments.



The table on page 23 summarizes the programmable features available and shows the page number where the feature is explained.

In the “Button” column, have your dealer record the name of the programmable button next to the feature that has been programmed to it.

The dealer can use the abbreviations (S1, S2, P1, or P2) shown in the radio illustration on page 11.



Also, where appropriate, have your dealer indicate whether the button press requires a short press, a long press, or needs to be held down.

Programmable Features

Feature	Indicator	Short Press	Long Press	Hold Down	Page	Button
Battery Indicator		—	—	Checks the battery charge status.	18	
Menu Mode	—	Ⓜ button enters Menu Mode and selects menu options. Once in Menu Mode, Ⓜ button is automatically re-assigned to exit Menu Mode.†		—	26	Ⓜ
Volume Set	—	—	—	Sounds a tone for adjusting the radio's volume level.	27	
Monitor		A long press initiates Monitor. A short press cancels Monitor.		Monitors the selected channel for any activity.	29	
Repeater/ Talkaround		Toggles between using a repeater or transmitting directly to another radio.†		—	31	
Revert Memory Channel (1&2)	—	Allows instant access to the home channel/ talkgroup.	—	—	32	



† This function is activated by EITHER a short OR a long press, but not both.

Programmable Features (Continued)

Feature	Indicator	Short Press	Long Press	Hold Down	Page	Button
Store Memory Channel (1&2)	—		Stores current channel/talkgroup to the home channel/talkgroup.	—	32	
Home Revert AutoKey (1&2)	—	If a Revert Memory Channel is an LTR talkgroup, the radio keys-up and transmits an MDC PTT ID. If a Revert Memory Channel is a conventional channel, it does not key-up.†		—	32	
Voice Operated Transmission (VOX)	—	Toggle VOX on and off.†		—	32	
Keypad Lock/Unlock			Toggle keypad between locked and unlocked.		34	
Radio Call	—	Directly access radio call menu.†		—	35,36	
Scan/Nuisance Channel/Talkgroup Delete		Starts or stops the Scan operation.	Deletes a nuisance channel/talkgroup while scanning.	—	39,40	
Edit Scan List	—	Add, delete, or prioritize channels/talkgroups.†		—	42	

† This function is activated by EITHER a short OR a long press, but not both.

Programmable Features (Continued)

Feature	Indicator	Short Press	Long Press	Hold Down	Page	Button
Phone		Directly access phone mode.†		—	45,46	
Speed Dial		Quickly access speed dial phone list.†		—	47	
Escalert	—	Toggle escalert on and off.†		—	54	
Squelch	—	Toggle squelch level between tight and normal squelch.†		—	57	
Power Level	LH	Toggle transmit power level between High and Low power.†		—	57	
Option Board		Toggle the option board on and off.†		—	58	
Lights	—	Toggle keypad and display backlights on and off.†		—	58	

† This function is activated by EITHER a short OR a long press, but not both.

MENU BUTTONS

Menu Button

If preprogrammed by your dealer, the two front buttons (P1) and (P2) can be used, in conjunction with other programmable features, to access and select menu options (P2); and exit menu mode (P1).

The (P2) button can be preprogrammed by your dealer to either a short or long press to access the Menu Mode.

Menu Scroll Buttons



Used to scroll while in Menu Mode.

Refer to the menu navigation chart for menu selectable features at the back of this manual.

Navigate the Menu



to scroll through the menu options. If you scroll past the last option, the selection wraps around and starts again.

When you reach the required option, a short press of the (P2) button selects that option and enters the sub-menu.

to scroll through the sub-menu options. Select the option with a short press of the (P2) button.

Exit the Menu

While in Menu Mode, the (P1) button is automatically assigned to completely exit the Menu Mode by a long press, or by a series of short presses to exit from a sub-level of the menu hierarchy.

The radio also exits the menu mode if there have been no inputs via the navigation buttons for the default “Inactivity Time” or after a selection has been made.

Once you have exited Menu Mode, the (P1) and (P2) buttons return to normal programmable condition.

GETTING STARTED

TURN THE RADIO ON OR OFF

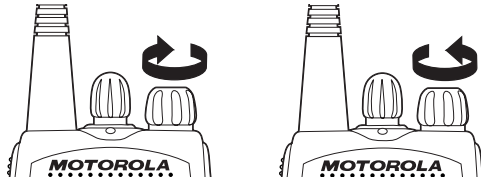

ON	OFF
<p>Rotate the On/Off/Volume knob clockwise. If power-up is successful, you will hear the Self-Test Pass Tone (<input type="checkbox"/><input type="checkbox"/>) and see the display icons light momentarily and the LED flash green. If the radio fails to power up, you will hear the Self Test Fail Tone (<input type="checkbox"/>). The radio will need to be returned for re-programming.</p>	<p>Rotate the On/Off/Volume knob counterclockwise until you hear a click and both the display and LED indicator turn off.</p>

ADJUST THE VOLUME

Turn the **On/Off/Volume Control** knob clockwise to increase the volume, or counterclockwise to decrease the volume.

–or–



Note: Your dealer can preprogram one of the programmable buttons to Volume Set.

- 1 Hold down the **Volume Set** button (see page 23).
 - You will hear a continuous tone.
- 2 Turn the **On/Off/Volume** knob to the desired volume level.
- 3 Release the **Volume Set** button.

SELECT AN LTR CHANNEL/ TALKGROUP

Your PR400 display radio can be programmed with up to 10 LTR sites and a maximum of 100 talkgroups, in total, across one or more sites (up to a total of 10 sites).

To select an LTR Channel/Talkgroup:

- 1 Turn the **Channel Selector** knob to select the appropriate LTR channel/talkgroup.
 –or–
 or  to select the appropriate LTR channel/talkgroup.
 –or–
 Press any of the programmable buttons to access a preprogrammed talkgroup. Then use either the **Channel Selector** knob or  and  to select the appropriate LTR channel/talkgroup.

Note: The third option is available only if your radio has been programmed with a specified LTR channel/talkgroup.



Note: Site/talkgroup settings are programmed by your dealer.

SELECT A CONVENTIONAL RADIO CHANNEL

Your radio offers 64 conventional channels.

To select a channel, turn the **Channel Selector** knob clockwise or counterclockwise until you reach the desired channel.

RECEIVE A CONVENTIONAL OR LTR CALL

- 1 Turn your radio on.
- 2 Adjust the radio's volume (see page 27).
- 3 Turn the **Channel Selector** knob to select the desired conventional channel or LTR talkgroup,
 –or–
 or  to select the desired conventional channel or LTR talkgroup.
 - Make sure the **PTT** button is released.

- 4 Listen for voice activity.
 - The LED indicator flashes red while your radio is receiving.
- 5 To respond, hold the radio vertically 1 to 2 inches (2.5 to 5cm) from your mouth. Press the **PTT** button to talk; release it to listen.

MONITOR

It is important to monitor for traffic before transmitting to ensure that you do not “talk over” someone who is already transmitting.

- 1 Press and hold the preprogrammed **Monitor** button to access channel traffic.
 - If no activity is present, you will hear “white noise.”
 - 2 Once channel traffic has cleared, proceed with your call by pressing the **PTT** button.
-

Permanent Monitor

- 1 A long press of the preprogrammed **Monitor** button places the radio in Permanent Monitor mode.
 - You hear a good key tone.
 - 2 A short press of the **Monitor** button cancels Permanent Monitor mode and returns the radio to normal operation.
-

TRANSMIT AN LTR CALL

- 1 Turn the **Channel Selector** knob to select the appropriate LTR channel/talkgroup.

–or–

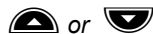

to select the appropriate LTR channel/talkgroup.

- 2 Hold the microphone in a vertical position at a distance of about 1 to 2 inches (2.5 to 5 cm) from your mouth.

- 3 Press and hold the **PTT** button.

–or–

Press and release the **PTT** button and wait 3 seconds.

- If access to the trunked system was successful, the red LED indicator lights steady.
- If access to the trunked system was unsuccessful, the red LED indicator flashes, indicating that the system was busy or out-of-range.

- 4 With the **PTT** button depressed, speak clearly into the microphone.

- 5 Release the **PTT** button to listen.

TRANSMIT A CONVENTIONAL CALL

- 1 Turn your radio on.

- 2 Use the **Channel Selector** knob to select the desired channel.

Note: Monitor for traffic before transmitting to ensure that you do not “talk over” someone who is already transmitting

- 3 Hold the radio vertically 1 to 2 inches (2.5 to 5cm) from your mouth. Press the **PTT** button to talk.

- The LED indicator lights steady red while the call is being sent.

- 4 Release the **PTT** to listen.

CALL LIGHT (TRUNKED OPERATION ONLY)

The **Call Light** indicator informs you that you have received a call from a specified LTR® talkgroup (as programmed by your dealer). The yellow LED indicator will flash continuously, indicating that a call has been received.

To turn the call light off:

- turn the radio off, then on again, or
- change the channel/talkgroup, or
- press the **PTT** button, or
- press any valid button.

REPEATER OR TALKAROUND |→| MODE

Talkaround Mode enables you to communicate with another radio when either:









- The repeater is not operating.
- or–
- Your radio is out of the repeater's range but within communicating distance of another radio.

Note: The |→| symbol appears on the display when Talkaround Mode is selected.

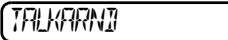
To Select either Repeater Mode or Talkaround Mode

Press the preprogrammed **Repeater/**
Talkaround button (see page 23) to toggle
between Repeater Mode and Talkaround Mode.

– or –

- 1  to enter menu mode.
- 2  or  until 
- 3  to select the current setting.
- 4  or  until 
-or- until 
- 5  to select the current setting.

REVERT MEMORY CHANNEL (1 & 2)

The Revert Memory Channel feature allows you to instantly access up to two of your favorite channels/talkgroups at the touch of a button.

Press the preprogrammed **Revert Memory Channel 1** button or **Revert Memory Channel 2** button (see page 23).

STORE MEMORY CHANNEL (1 & 2)

The Store Memory Channel (1 & 2) feature allows you to store a channel/talkgroup for the Revert Memory Channel feature.

Use the **Channel Selector** knob to select the desired channel/talkgroup. Press the preprogrammed **Store Memory Channel 1** button or **Store Memory Channel 2** button to store that channel/talkgroup (see page 23).

HOME REVERT AUTOKEY (1 & 2)

If a Revert Memory Channel is an LTR talkgroup, the Home Revert AutoKey feature automatically keys-up and transmits an MDC PTT ID. If a Revert Memory Channel is programmed as a Conventional channel, the radio will not key-up (see page 24).

VOX OPERATION

When hands-free operation is desired, your radio can transmit by voice alone using the VOX feature when you speak through an accessory that is connected to your radio.

Connecting a VOX Headset

- 1 Turn off your radio.
- 2 Connect the VOX accessory to your radio and turn the radio on.

Enable or Disable VOX

To enable or disable VOX operation, press the preprogrammed **VOX** button (see page 24).

Note: Pressing the **PTT** button disables VOX.

– or –

You can select channels/talkgroups to enable or disable VOX as preprogrammed by your dealer/programmer.

- 1 Select a channel/talkgroup that has been preprogrammed by your dealer to enable VOX.

Note: Pressing the **PTT** button disables VOX.

- 2 Select a channel/talkgroup that has not been preprogrammed by your dealer to disable VOX.

ENABLE/DISABLE HEADSET SIDETONE

Your dealer can program your radio so you can hear your voice through a headset while you speak.

VOX Headset

- 1 To enable the headset sidetone, turn off your radio.
- 2 Connect the VOX headset accessory to your radio.

- 3 Turn the radio on. During transmit, you will hear your voice through the headset while you speak.

- 4 To disable the headset sidetone, turn off your radio and turn the radio on again.

Non-VOX Headset with In-Line PTT

- 1 To enable the headset sidetone, turn off your radio.

- 2 Connect the non-VOX accessory to your radio.

- 3 Press and hold the In-line PTT on your headset.

- 4 Turn the radio on and release the PTT once the radio has completed start-up. During transmit, you will hear your voice through the headset while you speak.

- 5 To disable the headset sidetone, turn off your radio and turn the radio on again.

KEYPAD LOCK/UNLOCK

To lock or unlock the keypad, long press the preprogrammed **Keypad Lock/Unlock** button (see page 24).

Note: The  symbol appears on the display when the keypad is locked.

PROGRAM PL/DPL CODES

Use this feature to edit the Private-Line/Digital Private-Line codes for a selected channel/talkgroup.

1  to enter menu mode.



2  or  until 

3  to select 

4  or  until 

- or - until 

5  to select the current setting.

6  or  to scroll through the standard TPL frequencies or DPL codes.

- or -

Enter a non-standard or standard 4-digit TPL frequency or the 3-digit octal (numbers 0-7 only) code for DPL via the DTMF microphone keypad.

7  to confirm selection.

8  until you exit menu mode.

RADIO CALLS

SELECTIVE RADIO INHIBIT

Your radio is equipped with a security feature that can temporarily render the unit inoperative when an inhibit signal is sent from the base station.

This feature is commonly used to disable radios:

- In case of theft
- For system control reasons

When your radio has been rendered inoperative by the base station, all controls will be inoperative except for the **On/Off** button and the display shows INHIBIT.

RECEIVE A SELECTIVE CALL (CONVENTIONAL OPERATION ONLY)

When you receive a selective call:

- The display shows  and the preprogrammed name or ID (MDC1200) of the calling radio, or you will hear a Call Alert tone (QCII) of the calling radio.

- The LED indicator flashes yellow, if programmed by your dealer/programmer.
- You hear two high-pitched tones.

- 1 To acknowledge the call, press and release the **PTT** button.
- 2 Press and hold the **PTT** button to talk; release to listen.

SEND A SELECTIVE CALL (CONVENTIONAL OPERATION ONLY)

You can send a Selective Call to a particular radio or to a group of radios, as programmed by your dealer.

Press the preprogrammed **Radio Call** button (see page 24), and proceed to step 4.

– or –



1  to enter menu mode

2  or  until 

3  to select 

4  or  until 

5  to select 

6  or  to locate the desired ID in the Radio Call List.

- or -

Enter a valid DTMF digit (0-9) to move to that location in the list.

7 Press the **PTT** button to send the call.

8 Press and hold the **PTT** button to talk; release to listen.

9 When the call is completed,  until you exit menu mode.

RECEIVE A CALL ALERT™ PAGE (CONVENTIONAL OPERATION ONLY)

When you receive a Call Alert page:

- The display shows  and the preprogrammed name or ID of the calling radio.
- The LED indicator flashes yellow, if programmed by your dealer/programmer.
- You hear four high-pitched tones.

To acknowledge the page, press and release the **PTT** button; to cancel the page, press any other key.

SEND A CALL ALERT PAGE (CONVENTIONAL OPERATION ONLY)

You can alert another person by sending a Call Alert page.

Press the preprogrammed **Radio Call** button (see page 24) and proceed to step 4.

- or -



1  to enter menu mode

2  or  until 

3  to select 

4  or  until 

5  to select 

6  or  to locate the desired ID in the Radio Call List.

- or -

Enter a valid DTMF digit (0-9) to move to that location in the list.

7 Press the **PTT** button to send the page.

8 When the page is completed,
 until you exit menu mode.

REPEATER ACCESS

Use this feature to send DTMF tones to a repeater.

- 1 Press and hold the **PTT** button and enter your access code using the DTMF keypad.
- 2 Press and release the required DTMF buttons.
- 3 Release the **PTT** button.

RADIO CHECK

Radio Check allows you to determine if a radio is within the range of the trunked system and turned on, without disturbing the user of that radio. This feature can also be used when attempts with Selective Call and Call Alert fail.

Notes:

SCAN

Your radio is equipped with the Scan feature, which allows you to monitor multiple channels/talkgroups for voice activity. The radio will stop on a channel/talkgroup when it detects activity on it.

Scan lists are assigned per channel/talkgroup, by your dealer/programmer. Your radio automatically switches to a channel/talkgroup, within that scan list, when it detects activity. You can edit these lists through your radio's menu (see page 42).

- The LED indicator blinks green during scan mode; it stops blinking when the radio switches to an active channel/talkgroup.
- The  symbol appears on the display while in scan mode.

There are two ways that your radio scans:

- System Scan (manual)
- Auto Scan (automatic)

TALKBACK

The Talkback feature allows you to respond to a transmission while scanning. If transmission is detected on a channel/talkgroup while scanning, the radio will stop on that channel/talkgroup for a default period of time after activity has ceased. This is referred to as “hangtime”. During this hangtime you may respond by pressing the **PTT** button.

Note: The LED scan indicator stops blinking while the radio is in hangtime. If the **PTT** button is not pressed after the preprogrammed hangtime, the radio returns to scanning channels/talkgroups.



START SYSTEM SCAN

Press the preprogrammed **Scan** button to start scanning channels/talkgroups in your scan list (if Auto Scan is not enabled) (see page 24).

– or –

1 Select a channel or talkgroup that contains a Scan list.

2  to enter menu mode.



3  or  until



- 4  to select



The display shows the current scan status.

- 5  or  until





- 6  to select the current setting.

STOP SYSTEM SCAN

Press the preprogrammed **Scan** button to stop System Scan (see page 24).

– or –

- 1  to enter menu mode.



- 2  or  until



- 3  to select



The display shows the current scan status.

- 4  or  until



- 5  to select the current setting.

- The  symbol disappears from the display.

Note: Your dealer/programmer can preprogram your radio when exiting System Scan to automatically revert to the last scan channel/talkgroup that had activity on it or to automatically revert to the channel/talkgroup where scan was initiated.

START AUTO SCAN

Auto Scan automatically starts scanning once a channel/talkgroup with Auto Scan enabled is selected.

Select a channel/talkgroup that has been preprogrammed for Auto Scan by your dealer/programmer.

STOP AUTO SCAN

Select a channel/talkgroup that has not been preprogrammed for Auto Scan by your dealer/programmer.

- The  symbol disappears from the display.

DELETE A NUISANCE CHANNEL/ TALKGROUP

Note: Your dealer/programmer must preprogram a button to access this feature (see page 24).

If a channel or talkgroup continually generates unwanted calls or noise (a “nuisance” channel/talkgroup), you can temporarily remove it from the scan list:

- 1 While the radio is on the nuisance channel/talkgroup, press the preprogrammed **Nuisance Channel Delete** button until you hear a tone.
- 2 Release the **Nuisance Channel Delete** button. The nuisance channel/talkgroup is deleted.

Note: You cannot temporarily delete the channel/talkgroup that has been preprogrammed by your dealer/programmer as your designated scan channel/talkgroup, a priority channel/talkgroup, or the last remaining channel/talkgroup in the scan list.

Restore Channels/Talkgroups to the Scan List

- 1 Power off the radio. Once the radio is powered on again, the deleted nuisance channels/talkgroups are restored to the scan list.

– or –

Press the preprogrammed **Scan** button to stop the scan.

- 2 Press the preprogrammed **Scan** button again to start scanning again. The deleted nuisance channels/talkgroups are restored to the scan list.

– or –

Select a channel/talkgroup that has **not** been preprogrammed for scan by your dealer / programmer to stop Scan. Once you return to the original channel/talkgroup, the deleted nuisance channels/talkgroups are restored to the scan list.

EDIT A SCAN LIST

Your radio can support up to 16 Scan lists. Each Scan list can contain up to 16 channels/talkgroups. The same channel/talkgroup can be included in several Scan lists, and the same Scan list can be assigned to several channels/talkgroups. Scan lists are assigned per channel/talkgroup, by your dealer/programmer. When you edit a Scan list, you can either add, delete, or prioritize channels/talkgroups.

Note: Your radio cannot receive calls while you are editing a Scan list.

ADD OR DELETE CHANNELS/TALKGROUPS IN A SCAN LIST

1 Select a channel/talkgroup that contains a Scan list you want to edit.

2  to enter menu mode.

3  or  until 

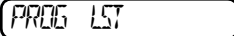
4  to select 

5  or  until 



Note: One Scan list per channel/talkgroup is available.

6  to select 

7  or  until 

– or – until 

8  to select the current setting.

9  or  until you see the channel/talkgroup you want to add or delete.

10  to confirm your selection.

11 If you added a channel/talkgroup,

you see: 
– or –

If you delete a channel/talkgroup,

you see: 

12  to confirm the deletion.

you see: 

13 **P1** to return to

ADD ITEM

– or –

DELETE

14 **P1** until you exit menu mode.

PRIORITIZE A CHANNEL OR TALKGROUP IN A SCAN LIST

You may want to check the activity on one or two channels/talkgroups more frequently than others. You can do this by prioritizing them:

Priority Channel/ Talkgroup	Scanning Sequence
None specified	Ch1 → Ch2 → Ch3 → Ch4 → ... Ch1
Channel/ Talkgroup 2 (Priority 1)	Ch2 → Ch1 → Ch2 → Ch3 → Ch2 → Ch4 → Ch2 → ... Ch1
Channel/ Talkgroup 2 (Priority 1) and Channel/ Talkgroup 8 (Priority 2)	Ch2 → Ch1 → Ch8 → Ch3 → Ch2 → Ch4 → Ch8 → ... Ch1

Note: If you are receiving on a non-priority channel/talkgroup and traffic becomes active on a priority channel/talkgroup, your radio will automatically switch to that priority channel/talkgroup and indicate the activity with a short tone.

Set Priority Channels/Talkgroups

Note: You cannot assign the same priority to two different channels/talkgroups.

1  to enter menu mode.

2  or  until 

3  to select 

4  or  until 

5  to select 

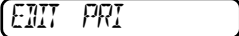
6  or  until 



7  to select 

8  or  until 

– or – until 

9  to select the desired priority level.

You see the current priority channel/talkgroup.

10  or  until you see the channel/talk-group you want to prioritize.

– or – until
to select the current
channel/talkgroup the
radio is on.

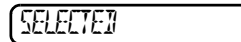

– or – until
to de-prioritize the
current channel/talk-
group the radio is on.

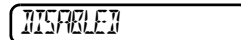



11  to prioritize that channel/talkgroup.

you see:

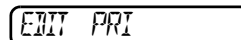

12  to return to



13  until you exit menu mode.

PHONE

Your radio allows you to place and receive telephone calls through a repeater (depending on phone line availability). You can edit the phone list through your radio's menu (see page 48).

The phone feature is available in both conventional and LTR systems.

-  appears on the display when you are in Phone mode.

ACCESS THE REPEATER

Your dealer/programmer can preprogram your radio in one of three ways to enter your access/de-access code to the repeater.

Immediate Auto – your radio will transmit the access/deaccess code automatically upon entering phone mode or disconnecting a phone call. You will hear a series of tones, and see your access/deaccess code on the display, indicating that an access/deaccess code is being sent automatically.

Delayed Auto – your radio will transmit the access code upon a **PTT** button press. The de-

access code is sent automatically when you exit phone mode.

Manual - Enter your access/deaccess code using the DTMF keypad.

RECEIVE A PHONE CALL



When a phone call is received, a ringing tone sounds, alerting you to answer the phone call.

Press the preprogrammed **Phone** button (see page 24), and skip to step 6.

– or –

1 Select a channel/talkgroup that has been programmed for telephone.

2  to enter menu mode.

3  or  until

PHONE

4  to select

PHONE

Note: The  appears on the display.

5 Enter your repeater access code, if necessary (see page 45).

- 6 Press and hold the **PTT** button to talk. Hold the radio in a vertical position with the microphone 1 to 2 inches (2.5 to 5 cm) away from your mouth. Release the **PTT** button when the other party wants to talk, both parties will need to speak in turn.

- 7 Disconnect the phone call when the conversation is completed.



DISCONNECT A PHONE CALL

- 1 To disconnect a phone call, do one of the following:

If your radio has **Immediate Auto** or **Delayed Auto** programmed, go to step 2.

– or –

Enter the deaccess code using the DTMF keypad and press the **PTT** button.

- 2 To exit Phone Mode:
Press the preprogrammed **Phone** button (see page 24).
– or –
Press and hold  to disconnect the call.
Note:  disappears from the display.

MAKE A PHONE CALL



Note: Only the first 8 digits of the phone number will be displayed on your radio's display.

Press the preprogrammed **Phone** button (see page 21), and skip to step 6.

– or –

- 1 Select a channel/talkgroup that has been programmed for telephone.

- 2  to enter menu mode.

- 3  or  until



- 4  to select



- 5 Enter your repeater access code, if necessary (see page 45).

- 6 When you hear a dial tone:

Enter the phone number using the DTMF keypad.



– or –



select a number from the phone list.

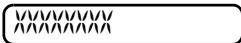

– or –

- a. Press and release the preprogrammed **Speed Dial** button.
- a. Press the key (0 to 9) corresponding to the number you want to call.

Note: To redial the last number dialed (if not using Speed Dial), press and release the **PTT** button immediately after the access code is sent. The radio sends the last number dialed.

7

– or –

If you entered your access code using the DTMF keypad, press  once to access the last number dialed; then press and release the **PTT** button.

- 8 Press and release the **PTT** button, if required for your radio.

- 9 When your party answers, press and hold the **PTT** button to talk. Hold the radio in a vertical position with the microphone 1 to 2 inches (2.5 to 5 cm) away from your mouth. Release the **PTT** button when the other party wants to talk, both parties will need to speak in turn.

- 10 Disconnect the phone call when the conversation is completed (see page 46).

EDIT THE PHONE LIST

Your radio contains a Phone list that holds up to 25 phone numbers. You can edit the Phone list in three ways through your radio's menu:

- Add an entry
- Delete an entry
- Edit an existing entry

Add an Entry

- 1 to enter menu mode.
- 2 or until
- 3 to select
- 4 or until
- 5 to select
- 6 or until
- 7 to select,
you see:

- 8 Use the DTMF keypad to enter the name (see Entering Characters Using the DTMF Keypad on page 20.)

- 9 to store the name,

you see:

- 10 Use the DTMF keypad to enter the phone number. You can also add a Pause Indicator by holding until 'P' appears on the display.

- 11 to store the phone number.

you see:

- 12 or until you see the location in the list where you want to store the phone number.

- 13 to store the phone number,

you see:

- 14 to return to
– or –



until you exit menu mode.

Delete an Entry

- 1 to enter menu mode.
- 2 or until
- 3 to select
- 4 or until
- 5 to select
- 6 or until
- 7 to select
- 8 or until you see the entry you want to delete.
- 9 to select the entry, you see:
- 10 again to confirm the deletion, you see:
- 11 to return to – or –
 until you exit menu mode.

Edit an Entry

- 1 to enter menu mode.
- 2 or until
- 3 to select
- 4 or until
- 5 to select
- 6 or until
- 7 to select
- 8 or until you see the entry you want to edit.
- 9 to select the entry.
- 10 or until (to edit the name),
– or – until (to edit the phone number),
– or – until (to edit the location in the phone list),

- 11  to confirm your selection.
- 12 Use the DTMF keypad to edit the entry (see Entering Characters Using the DTMF Keypad on page 20.)
– or –
 or  until you see the location where you want to store the phone number.

13  to store the information.

14 you see:

SAVED

15  to return to

EDIT



– or –

 until you exit menu mode.

Edit Access/Deaccess Codes

You can edit the access/de-access codes that are used to connect or disconnect you from a repeater.



1  to enter menu mode.

2  or  until

PROG LST

3  to select



PROG LST

4  or  until

PHN LST

5  to select



PHN LST

6  or  until

EXIT CODE

7  to select

EXIT CODE

8  or  until

ACCESS

– or – until

DEACCESS



9  to select the current setting.

10 Enter the number using the DTMF keypad.

11  to select the entry.

12 you see:













SAVED

13  or  to edit another code.

14  until you exit menu mode.

TONE PREFERENCES

You can use the radio's menu to access user-adjustable settings to customize the tones on your radio.

- 1  to enter menu mode.
- 2  or  until 
- 3  to select 
- 4  or  until you see the feature you want to change (see the table on page 52).
- 5  to select the feature. You see the feature's current setting.
- 6  or  to see a list of available settings.
- 7  to select the desired setting.
- 8  until you exit the menu mode.

Tone Settings

Feature	What it Does	Settings
TONE	Turns all alert tones on or off.	ON OFF
KPTD TONE	Turns the keypad tones on or off.	ON OFF
TONE TAG	Assigns a specific tone when receiving a specific type of radio call.	STANDARD ALERT 1-6
ESCALERT	Increases the volume of the alarm tones when a radio call is not answered.	ON OFF

TONES ON/OFF

You can program your radio to enable or disable all alert tones.

1  to enter Menu mode.

2  or  until

3  to select

4  or  until

5  to select



6  or  until

– or – until

7  to select the desired setting.

KEYPAD ON/OFF TONES

You can program your radio to enable or disable all keypad tones.

Note: Tones for the programmable buttons , , and Side Buttons 1 and 2 can not be disabled.

1  to enter Menu mode.

2  or  until

3  to select

4  or  until

5  to select

6  or  until

– or – until

7  to select the desired setting.

CALL TONE TAGGING (CONVENTIONAL OPERATION ONLY)

You can program your radio to sound a particular alert tone when receiving Selective Call or Call Alert (call tone tagging).

Note: Seven alert tones are available to select from in the list.

- 1 to enter menu mode.
- 2 or until
- 3 to select
- 4 or until
- 5 to select
- 6 or until
- or – until
- 7 to select the desired setting.
- 8 or until you see and hear the tone you want to use for this type of call.
- 9 to select the desired setting.
- 10 you see:

11 to return to

12 until you exit the menu mode.

ESCALERT (CONVENTIONAL OPERATION ONLY)

You can program your radio to increase the volume of the alarm tones when a radio call is not answered.













Press the preprogrammed **Escalert** button (see page 24) and proceed to step 5.

– or –

- 1 to enter menu mode.
- 2 or until
- 3 to select
- 4 or until
- 5 to select
- 6 or until
- or until
- 7 to select the desired setting.

USER SETTINGS

You can use the radio's menu to access user-adjustable settings to customize some of your radio features.

- 1  to enter menu mode.
- 2  or  until 
- 3  to select 
- 4  or  until you see the feature you want to change (see table on page 56).
- 5  to select the feature. You see the feature's current setting.
- 6  or  for available settings.
- 7  to select the desired setting.

Utilities Features

Feature	What it Does	Settings
SQUELCH	Changes the squelch of the radio to tight or normal.	TIGHT NORMAL
PWR LVL	Changes the power level of the radio to high or low.	HIGH LOW
OPT BRD	Enables or disables an option board.	ON OFF
LIGHT	Enables or disables the radio's keypad and display backlight.	ON OFF
SOFTWARE	Displays the radio's software version number.	XXXXXXXX

SET SQUELCH LEVEL

Use this feature to filter out (unwanted) calls and/or background noise. However, tightening squelch could cause calls from remote locations to be filtered out as well. In this case, normal squelch may be more desirable.

Press the preprogrammed **Squelch** button (see page 25) to toggle between tight and normal squelch.

– or –

1  to enter menu mode.

2  or  until 

3  to select 

4  or  until 

5  to select 

6  or  until 

– or – until 

7  to select the current setting.

SET POWER LEVEL

Each channel/talkgroup in your radio has a predefined transmit power level that can be changed.



- *High power* (**H**) allows you to reach a radio that is farther away.
- *Low power* (**L**) to conserve the battery.

Note: The **L** or **H** symbol appears on the display when High/Low Power Level is selected.

To set the power level, press the preprogrammed **Power Level** button (see page 25) to toggle between low and high power.

– or –

1  to enter menu mode.

2  or  until 

3  to select 

4  or  until 

5  to select 

6 or until
 – or – until

7 to select the current setting.

OPTION BOARD ON/OFF

Use this feature to enable or disable an option board.

- The symbol appears on the display when the option board feature is On.

Press the preprogrammed **Option Board** button (see page 25) to toggle the option board on or off.

– or –

1 to enter menu mode.

2 or until

3 to select

4 or until

5 to select

6 or until
 – or – until

7 to select the current setting.

SET THE LIGHTS

Use this feature to enable or disable the radio's keypad and display backlight.

1 to enter menu mode.

2 or until

3 to select

4 or until

5 to select

6 or until

– or – until

7 to select the current setting.

DISPLAY THE SOFTWARE VERSION

Use this feature to view the current software version of your radio.

1  to enter menu mode.

2  or  until 

3  to select 

4  or  until 

5  to view the software version.

6  until you exit menu mode.

Notes:

WARRANTY

LIMITED WARRANTY MOTOROLA COMMUNICATION PRODUCTS

I. WHAT THIS WARRANTY COVERS AND FOR HOW LONG:

MOTOROLA INC. (“MOTOROLA”) warrants the MOTOROLA manufactured Communication Products listed below (“Product”) against defects in material and workmanship under normal use and service for a period of time from the date of purchase as scheduled below:

PR400 Portable Units	Two (2) Years
Product Accessories	One (1) Year

MOTOROLA, at its option, will at no charge either repair the Product (with new or reconditioned parts), replace it (with a new or reconditioned Product), or refund the purchase price of the Product during the warranty period provided it is returned in accordance with the terms of this warranty. Replaced parts or boards are warranted

for the balance of the original applicable warranty period. All replaced parts of Product shall become the property of MOTOROLA.

This express limited warranty is extended by MOTOROLA to the original end user purchaser only and is not assignable or transferable to any other party. This is the complete warranty for the Product manufactured by MOTOROLA.

MOTOROLA assumes no obligations or liability for additions or modifications to this warranty unless made in writing and signed by an officer of MOTOROLA. Unless made in a separate agreement between MOTOROLA and the original end user purchaser, MOTOROLA does not warrant the installation, maintenance or service of the Product.

MOTOROLA cannot be responsible in any way for any ancillary equipment not furnished by MOTOROLA which is attached to or used in connection with the Product, or for operation of the Product with any ancillary equipment, and all such equipment is expressly excluded from this warranty. Because each system which may use the Product is unique, MOTOROLA disclaims liability for range, coverage, or operation of the system as a whole under this warranty.

II. GENERAL PROVISIONS:

This warranty sets forth the full extent of MOTOROLA'S responsibilities regarding the Product. Repair, replacement or refund of the purchase price, at MOTOROLA's option, is the exclusive remedy. THIS WARRANTY IS GIVEN IN LIEU OF ALL OTHER EXPRESS WARRANTIES. IMPLIED WARRANTIES, INCLUDING WITHOUT LIMITATION, IMPLIED WARRANTIES OF MERCHANTABILITY AND FITNESS FOR A PARTICULAR PURPOSE, ARE LIMITED TO THE DURATION OF THIS LIMITED WARRANTY. IN NO EVENT SHALL MOTOROLA BE LIABLE FOR DAMAGES IN EXCESS OF THE PURCHASE PRICE OF THE PRODUCT, FOR ANY LOSS OF USE, LOSS OF TIME, INCONVENIENCE, COMMERCIAL LOSS, LOST PROFITS OR SAVINGS OR OTHER INCIDENTAL, SPECIAL OR CONSEQUENTIAL DAMAGES ARISING OUT OF THE USE OR INABILITY TO USE SUCH PRODUCT, TO THE FULL EXTENT SUCH MAY BE DISCLAIMED BY LAW.

III. STATE LAW RIGHTS:

SOME STATES DO NOT ALLOW THE EXCLUSION OR LIMITATION OF INCIDENTAL

OR CONSEQUENTIAL DAMAGES OR LIMITATION ON HOW LONG AN IMPLIED WARRANTY LASTS, SO THE ABOVE LIMITATION OR EXCLUSIONS MAY NOT APPLY.

This warranty gives specific legal rights, and there may be other rights which may vary from state to state.

IV. HOW TO GET WARRANTY SERVICE:

You must provide proof of purchase (bearing the date of purchase and Product item serial number) in order to receive warranty service and, also, deliver or send the Product item, transportation and insurance prepaid, to an authorized warranty service location. Warranty service will be provided by MOTOROLA through one of its authorized warranty service locations. If you first contact the company which sold you the Product (e.g., dealer or communication service provider), it can facilitate your obtaining warranty service. You can also call MOTOROLA at 1-800-927-2744 US/ Canada.

V. WHAT THIS WARRANTY DOES NOT COVER:

- A) Defects or damage resulting from use of the Product in other than its normal and customary manner.
- B) Defects or damage from misuse, accident, water, or neglect.
- C) Defects or damage from improper testing, operation, maintenance, installation, alteration, modification, or adjustment.
- D) Breakage or damage to antennas unless caused directly by defects in material workmanship.
- E) A Product subjected to unauthorized Product modifications, disassembles or repairs (including, without limitation, the addition to the Product of non-MOTOROLA supplied equipment) which adversely affect performance of the Product or interfere with MOTOROLA's normal warranty inspection and testing of the Product to verify any warranty claim.
- F) Product which has had the serial number removed or made illegible.
- G) Rechargeable batteries if:
 - 1) any of the seals on the battery enclosure of cells are broken or show evidence of tampering.
 - 2) the damage or defect is caused by charging

or using the battery in equipment or service other than the Product for which it is specified.

- H) Freight costs to the repair depot.
- I) A Product which, due to illegal or unauthorized alteration of the software/firmware in the Product, does not function in accordance with MOTOROLA's published specifications or the FCC type acceptance labeling in effect for the Product at the time the Product was initially distributed from MOTOROLA.
- J) Scratches or other cosmetic damage to Product surfaces that does not affect the operation of the Product.
- K) Normal and customary wear and tear.

VI. PATENT AND SOFTWARE PROVISIONS:

MOTOROLA will defend, at its own expense, any suit brought against the end user purchaser to the extent that it is based on a claim that the Product or parts infringe a United States patent, and MOTOROLA will pay those costs and damages finally awarded against the end user purchaser in any such suit which are attributable to any such claim, but such defense and payments are conditioned on the following:

- A) that MOTOROLA will be notified promptly in writing by such purchaser of any notice of such

- claim;
- B)that MOTOROLA will have sole control of the defense of such suit and all negotiations for its settlement or compromise; and
- C)should the Product or parts become, or in MOTOROLA's opinion be likely to become, the subject of a claim of infringement of a United States patent, that such purchaser will permit MOTOROLA, at its option and expense, either to procure for such purchaser the right to continue using the Product or parts or to replace or modify the same so that it becomes non-infringing or to grant such purchaser a credit for the Product or parts as depreciated and accept its return. The depreciation will be an equal amount per year over the lifetime of the Product or parts as established by MOTOROLA.

MOTOROLA will have no liability with respect to any claim of patent infringement which is based upon the combination of the Product or parts furnished hereunder with software, apparatus or devices not furnished by MOTOROLA, nor will MOTOROLA have any liability for the use of ancillary equipment or software not furnished by MOTOROLA which is attached to or used in connection with the Product. The foregoing states the entire liability of MOTOROLA with respect to infringement of patents by the Product or any

parts thereof.

Laws in the United States and other countries preserve for MOTOROLA certain exclusive rights for copyrighted MOTOROLA software such as the exclusive rights to reproduce in copies and distribute copies of such MOTOROLA software. MOTOROLA software may be used in only the Product in which the software was originally embodied and such software in such Product may not be replaced, copied, distributed, modified in any way, or used to produce any derivative thereof. No other use including, without limitation, alteration, modification, reproduction, distribution, or reverse engineering of such MOTOROLA software or exercise of rights in such MOTOROLA software is permitted. No license is granted by implication, estoppel or otherwise under MOTOROLA patent rights or copyrights.

VII.GOVERNING LAW:

This Warranty is governed by the laws of the State of Illinois, USA.

ACCESSORIES

Motorola offers a number of accessories to enhance the productivity of your two-way radio. Many of the available accessories are listed below.

ANTENNAS

NAD6502_R	VHF Heliflex Antenna 14cm, 146-174 MHz
HAD9742	VHF Stubby Antenna, 9cm, 146-162 MHz
HAD9743	VHF Stubby Antenna, 9cm, 162-174 MHz
NAE6522_R	UHF Heliflex Stubby Antenna 9cm, 438-470 MHz
NAE6483_R	Flexible Whip Antenna, 403-520 MHz
8505816K26	UHF Heliflex Stubby, 470-520 MHz

BATTERIES

NNTN4496_R	NiCd, 1100 mAh
NNTN4497_R	Li-Ion, 1800 mAh
NNTN4851	NiMH, 1400 mAh
NNTN4852	NiMH FM, 1300 mAh
NNTN4970	Slim Li-Ion, 1600 mAh

CARRY ACCESSORIES

RLN5496	Leather DTMF Case with 2-1/2 inch Swivel (for Full-Display models)
RLN5497	Leather DTMF Case with 3 inch Swivel (for Full-Display models)
RLN5498	Leather DTMF Case with Belt Loop (for Full-Display models)
RLN5640	Leather LTD DTMF Case with Belt Loop (for Limited Display models)
RLN5641	Leather LTD DTMF Case with 2-1/2 inch Swivel (for Limited Display models)
RLN5642	Leather LTD DTMF Case with 3 inch Swivel (for Limited Display models)
RLN5383	Leather Case with Belt Loop (For Non-Display models)
RLN5384	Leather Case with 2-1/2 inch Swivel (for Non-Display models)
RLN5385	Leather Case with 3 inch Swivel (for Non-Display models)
HLN9701	Nylon Case with Belt Loop (For all models)
HLN8255	3 inch Spring Action Belt Clip
RLN5644	2 inch Spring Action Belt Clip
NTN5243	Shoulder Strap for Hard Leather Cases (attaches to D-Shaped Rings on case)
HLN6602	Universal Chest Pack

RLN4815	Universal Radio Pak
RLN4570	Break-A-Way Chest Pack
1505596Z02	Replacement Strap for HLN6602 Universal Chest Pack
4280384F89	Belt Lengthener for RLN4815 Universal Radio Pak
HLN9985	Waterproof Bag

CHARGERS

WPLN4138_R	90 Min. Rapid Desktop Charger w/ US NA Plug
EPNN7997	10 Hr. US NA 120 V Plug (plugs into radio accessory connector, used ONLY with battery NNTN4496)
WPLN4155_R	10 Hr. Desktop Charger w/US NA Plug
EPNN7994	90 Min. Rapid US NA 120 V Plug
WPLN4161_R	Multi-Unit Rapid Charger w/US NA Plug

HEADSETS

RLN5411	Ultra-Lite Behind the Head Headset
PMMN4001	Earset with Flexible Boom Microphone

HMN9013	Lightweight Headset w/o In-line PTT
RMN4016	Lightweight Headset with In-line PTT
RLN5238	Lightweight Headset with In-line PTT, NFL Style
HMN9021	Medium Weight Over the Head Dual Muff Headset
HMN9022	Medium Weight Behind the Head Dual Muff Headset
BDN6647	Medium Weight Single Speaker Headset
BDN6648	Heavy Duty Dual Muff Headset with Noise Canceling Microphone
RMN5015	Heavy Duty Dual Muff Racing Headset (requires RKN4090 Headset Adapter Cable)
RKN4090	Adapter Cable for use with RMN5015 Racing Headset
RMN4051	2-Way Hard Hat Mount, Black, Noise Reduction Rating (22db) (requires RKN4094 Adapter Cable)
RMN4054	Receive-Only Hard Hat Mount Headset with 3.5mm Right Angle Plug
RMN4055	Receive-Only Headband Style Headset with 3.5mm Right Angle Plug
RKN4094	In-Line PTT Adapter for use with headset RMN4051 only

REX4648	Replacement Foam Ear Pad and Windscreen Kit for use with headsets HMN9013 & RMN4016
7580376E34	Replacement Ear Seals for use with headsets HMN9021 & HMN9022
5080371E66	Replacement Ear Pad for use with headset BDN6647
3580371E59	Replacement Windscreen for use with headset BDN6647

SURVEILLANCE ACCESSORIES

HMN9752	Earpiece with Volume Control, 1-Wire (plastic earloop) (Beige)
HMN9727	Earpiece without Volume Control, 1-Wire (plastic earloop) (Beige)
RLN4894	Earpiece without Volume Control, 1-Wire (plastic earloop) (Black)
HMN9754	Earpiece with Microphone & PTT Combined, 2-Wire (Beige)
RLN4895	Earpiece with Microphone & PTT Combined, 2-Wire (Black)
RLN5198_P	Earpiece with Microphone & PTT Combined (Black) including Low Noise Kit, 2-Wire Surveillance Kit w/ Clear Comfortable Acoustic Tube (includes NTN8371)

RLN5317	2-Wire Comfort Earpiece w/Mic & PTT for use with HMN9754 & NTN8371 (Beige)
RLN5318	2-Wire Comfort Earpiece w/Mic & PTT for use with RLN4894 & NTN8371 (Black)
BDN6720	Flexible Ear Receiver (receive only)
HMN9036	Earbud with Microphone & PTT Combined, 2-Wire (Black)
HLN9132	Earbud Single Wire Receive Only (Black)
NTN8370	Extreme Noise Kit
NTN8371	Low Noise Kit
RLN4760	Small Custom Clear Earpiece, Right Ear
RLN4763	Small Custom Clear Earpiece, Left Ear
RLN4761	Medium Custom Clear Earpiece, Right Ear
RLN4764	Medium Custom Clear Earpiece, Left Ear
RLN4762	Large Custom Clear Earpiece, Right Ear
RLN4765	Large Custom Clear Earpiece, Left Ear
5080384F72	Replacement Noise Attenuating Plug for NTN8370

5080371E73	Replacement Ear Tip for use with low noise kit NTN8371 (Beige)
5080371E75	Replacement Ear Tip for use with low noise kit NTN8371 (Black)
7580372E11	Replacement Ear Cushion for use with earpiece BDN6720

EAR MICROPHONE SYSTEMS

BDN6646	Standard 95 dB Ear Microphone with PTT Interface Module
BDN6706	Standard 95 dB Ear Microphone with VOX & PTT Interface Module
0180358B38	Ring Push-to-Talk Switch for ear microphone systems BDN6646 & BDN6706
0180300E83	Body Push-to-Talk Switch for ear microphone systems BDN6646 & BDN6706
0180300E25	Ear Guard with Adjustable Loop
0180358B32	Ear Holder, Small (Black)
0180358B33	Ear Holder, Medium (Black)
0180358B34	Ear Holder, Large (Black)
0180358B35	Ear Holder, Small (Clear)
0180358B36	Ear Holder, Medium (Clear)
0180358B37	Ear Holder, Large (Clear)

REMOTE SPEAKER MICROPHONES

HMN9030	Remote Speaker Microphone
HKN9094	Replacement Cord for HMN9030

MISCELLANEOUS

TDN9327	Portable Radio Hanger for door panels up to 2.75 inches (slides over and hangs from the door panel in vehicle, radio belt clip required)
TDN9373	Portable Radio Hanger for door panels up to 2.75 to 3.25 inches (slides over and hangs from the door panel in vehicle, radio belt clip required)
RLN5500	Accessory Retainer Kit (for use with any audio accessory that needs to be secured to the radio due to demanding customer environments)

Turn the Radio On or Off

1. Rotate the **On/Off/Volume** knob clockwise. You will hear the self-test pass tone and see the display icons light momentarily and LED indicator flash green.
2. Rotate the **On/Off/Volume** knob counterclockwise until you hear a click and both the display and the LED indicators turn off.





Adjust the Volume

1. Turn the **On/Off/Volume** knob clockwise to increase the volume, or counterclockwise to decrease the volume.

Select a Conventional Radio Channel

1. Turn the **Channel Selector** knob clockwise or counterclockwise until you reach the desired channel.

Select an LTR Channel/Talkgroup

1. Turn the **Channel Selector** knob to select the appropriate LTR channel/talkgroup. – OR –  or  to select the appropriate LTR channel/talkgroup. – OR – Press any of the programmable buttons to access a preprogrammed talkgroup. Then use either the **Channel Selector** knob or  and  to select the appropriate LTR channel/talkgroup.



Receive

1. Turn radio on and adjust volume to the desired level.
2. Select desired channel/talkgroup.
3. Listen for voice activity. The LED indicator flashes red while receiving.

Transmit

1. Hold the radio vertically 1 to 2 inches (2.5 to 5 cm) from your mouth. Press the **PTT** button to talk. The LED indicator lights steady red while sending.
2. Release **PTT** button to listen.

Start or Stop System Scan

1. Press the preprogrammed **Scan** button to start scan. – OR –  or  to select a channel/talkgroup that contains a Scan list. From the Scan menu, select **SCAN ON**. The LED indicator blinks green during scanning.
2. Press the preprogrammed **Scan** button again to stop scan. – OR – From the Scan menu, select **SCAN OFF**.

Delete a Nuisance Channel/Talkgroup During Scanning

1. While the radio is on a nuisance channel/talkgroup, hold down the preprogrammed **Nuisance Delete** button until you hear a tone.
2. Release **Nuisance Delete** button.



PR400™ Quick Reference Card

Record the functions for your radio's programmable buttons in the table provided below.

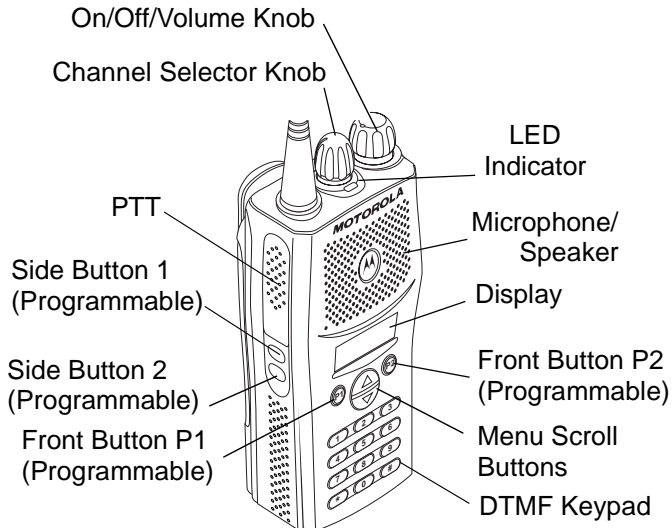

Button	Function	Short Press	Long Press	Hold Down	Page

Restore Channels/Talkgroups to the Scan List

Power off the radio then turn it on. – OR – Press the preprogrammed **Scan** button to stop the scan. The deleted nuisance channels/talkgroups are restored to the scan list. – OR – Select a channel/talkgroup that has **not** been preprogrammed for scan by your dealer/programmer. Once you return to the original channel/talkgroup, the deleted nuisance channels/talkgroups are restored to the scan list.

Send a Selective Call

1. From the Selective Call menu, select or enter desired radio ID number.
2. Press **PTT** button to send the call.
3. Press and hold the **PTT** button to speak; release to listen.

Receive a Selective Call

1. When a Selective Call is received, the radio displays 🎵 and the name or ID of the calling radio; the LED flashes yellow and two tones are heard.
2. Press **PTT** button to acknowledge the call.
3. Press and hold the **PTT** button to speak; release to listen.

LED Indicators

LED State/Color	Indication
Radio Call	
Red	Transmitting
Flashing Red	Receiving
Flashing Red	Channel/Talkgroup Busy
Scan	
Flashing Green	Scanning for activity
Call Alert	
Flashing Yellow	Indicates receiving a Call Alert
Yellow	Indicates sending a Call Alert
Selective Call	
Flashing Yellow	Indicates receiving a Selective Call
Yellow	Indicates sending a Selective Call
Sticky Monitor/Open Squelch	
Yellow	While monitoring

Audio Indicators for Programmable Buttons

Programmable Buttons	Positive Indicator Tone	Negative Indicator Tone
Scan	Start	Stop
Power Level	High	Low
Squelch	Tight	Normal
Repeater/Talkaround	Does not use repeater	Uses repeater
VOX	Enabled	Disabled
Silent Monitor/Open Squelch	–	Enabled
Revert Memory Channel (1&2)	–	Enabled
Store Memory Channel (1&2)	–	Stored
Home Revert AutoKey (1&2)	–	Enabled
Menu Mode (☺)	–	Accessed
Radio Call	–	Enabled
Scan List Edit	–	Enabled
Speed Dial	–	Enabled
Phone Mode	–	Enabled
Option Board	Enabled	Disabled
Escalert	Enabled	Disabled

You can check battery charge status if your dealer has preprogrammed one of the programmable buttons. Hold down the preprogrammed **Battery Indicator** button. The charge status is shown on the display.

Battery Level	Display
Full	
Good	
Fair	
Low	
Very Low	

Menu Navigation Chart

(Refer to Menu Navigation guidelines—
lower, left-hand corner of this page)

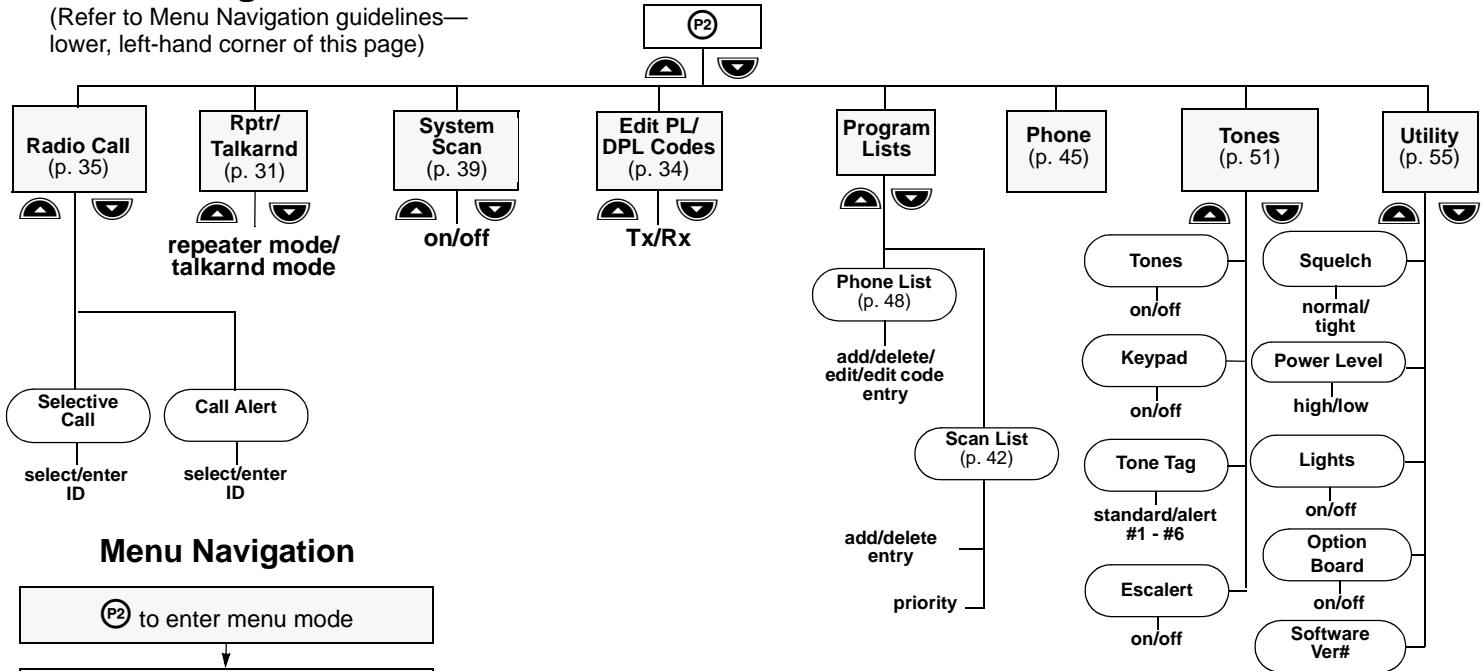

Menu Navigation

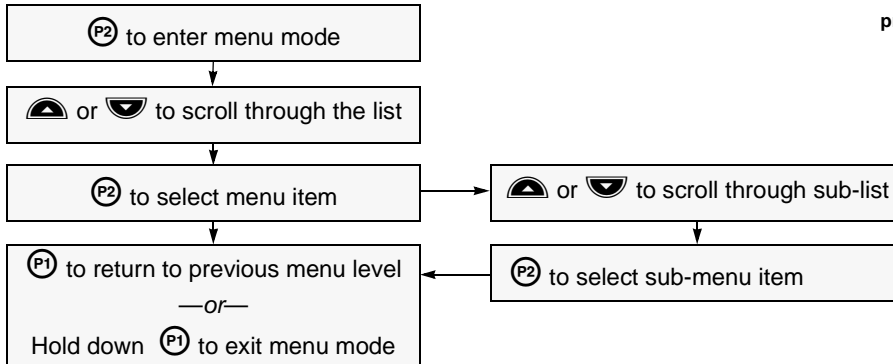



MOTOROLA and the Stylized M Logo are registered in the US Patent & Trademark Office.
All other product or service names are the property of their respective owners.
© Motorola, Inc. 2005. All rights reserved. Printed in U.S.A.

MOTOROLA et le logotype au M stylisé sont enregistrés auprès du Bureau des marques et brevets des États-Unis.
Tous les autres noms de produits et de services sont la propriété de leurs titulaires respectifs.
© Motorola, Inc. 2005. Tous droits réservés. Imprimé aux États-Unis.



6881096C23-C