



# Operator's Manual HC-2210/2810 Hedge Trimmer

## WARNING

*The engine exhaust from this product contains chemicals known to the State of California to cause cancer, birth defects, or other reproductive harm.*

## WARNING



*Read and understand all provided literature before use.  
Failure to do so could result in serious injury.*

This product complies with CAN ICES-2/NMB-2.

---

**TABLE OF CONTENTS**

---

|  |    |
|--|----|
| Table of Contents.....                               | 2  |
| Introduction .....                                   | 3  |
| Servicing Information .....                          | 3  |
| Parts/Serial Number.....                             | 3  |
| Service .....  | 4  |
| ECHO Consumer Product Support.....                   | 4  |
| Product Registration .....                           | 4  |
| Additional Literature .....                          | 4  |
| Safety.....  | 4  |
| Manual Safety Symbols and Important Information..... | 4  |
| International Symbols .....                          | 5  |
| Personal Condition and Safety Equipment .....        | 7  |
| Equipment.....                                       | 12 |
| Emission Control (Exhaust & Evaporative).....        | 13 |
| CARB And EPA Emissions Control Information .....     | 13 |
| Description .....                                    | 14 |
| Contents.....  | 15 |
| Assembly.....  | 16 |
| Operation .....                                      | 16 |
| Fuel .....   | 17 |
| Starting Cold Engine .....                           | 20 |
| Starting Warm Engine.....                            | 21 |
| Stopping Engine .....                                | 22 |
| Rotating operation .....                             | 23 |
| Hedge Trimming .....                                 | 24 |
| Maintenance .....                                    | 24 |
| Skill Levels.....                                    | 25 |
| Maintenance Intervals.....                           | 25 |
| Air Filter .....                                     | 26 |
| Fuel Filter.....                                     | 27 |
| Spark Plug .....                                     | 28 |
| Cooling System.....                                  | 28 |
| Exhaust System .....                                 | 29 |
| Carburetor Adjustment.....                           | 31 |
| Lubrication .....                                    | 32 |
| Blades.....  | 34 |
| Troubleshooting .....                                | 36 |
| Storage .....  | 38 |
| Long Term Storage (Over 30 Days).....                | 38 |
| Specifications.....                                  | 39 |
| Product Registration.....                            | 40 |
| Notes.....   | 42 |

# INTRODUCTION

Specifications, descriptions and illustrative material in this literature are as accurate as known at the time of publication, but are subject to change without notice. Illustrations may include optional equipment and accessories, and may not include all standard equipment.



Read and understand all provided literature. Literature contains specifications and information for safety, operation, maintenance, storage and assembly specific to this product. Scan QR codes for more information.



For additional literature, including safety manuals where applicable, or questions regarding terms used in this manual, visit:

<https://www.echo-usa.com/manuals>

OR



<https://www.shindaiwa-usa.com/manuals>

# SERVICING INFORMATION

## Parts/Serial Number

Genuine ECHO Parts and Assemblies for your ECHO products are available only from an Authorized ECHO Dealer. When you do need to buy parts always have the Model Number and Serial Number of the unit with you. For future reference write them in the space provided below.

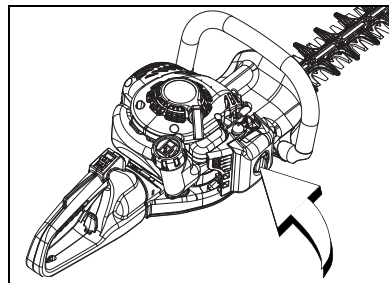

Model No. \_\_\_\_\_ Serial No. \_\_\_\_\_

## Service

Service of this product during the warranty period must be performed by an Authorized ECHO Service Dealer. For the name and address of the Authorized ECHO Service Dealer nearest you, ask your retailer or call: 1-800-432-ECHO (3246). Dealer information is also available on our Web Site [www.echo-usa.com](http://www.echo-usa.com). When presenting your unit for Warranty service/repairs, proof of purchase is required.

## ECHO Consumer Product Support

If you require assistance or have questions concerning the application, operation, or maintenance of this product, call the ECHO Consumer Product Support Department at 1-800-432-ECHO (3246) from 8:00 am to 5:00 pm (Central Standard Time) Monday through Friday. Before calling, please know the model and serial number of your unit.

## Product Registration

Register your ECHO equipment on-line at [www.echo-usa.com](http://www.echo-usa.com) or by filling out the product registration sheet included in this manual. Registering your product confirms warranty coverage and provides a direct link to ECHO if we find it necessary to contact you.

## Additional Literature

In addition to finding information online, information is available from your Authorized ECHO Service Dealer, or by contacting ECHO Inc., 400 Oakwood Road, Lake Zurich, IL 60047 (1-800-432-ECHO (3246)).

## SAFETY

---

### Manual Safety Symbols and Important Information

Throughout this manual and on the product itself, you will find safety alerts and helpful, informational messages preceded by symbols or key words. The following is an explanation of those symbols and key words and what they mean to you.

### **DANGER**

***The safety alert symbol accompanied by the word “DANGER” calls attention to an act or condition which WILL lead to serious personal injury or death if not avoided.***

**! WARNING**

*The safety alert symbol accompanied by the word “WARNING” calls attention to an act or condition which CAN lead to serious personal injury or death if not avoided.*

**! CAUTION**

*The safety alert symbol accompanied by the word “CAUTION” calls attention to an act or condition which may lead to minor or moderate personal injury if not avoided.*

**NOTICE**

*The enclosed message provides information necessary for the protection of the unit.*

Note: This enclosed message provides tips for use, care and maintenance of the unit.















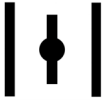



**CIRCLE AND SLASH SYMBOL**

This symbol means the specific action shown is prohibited. Ignoring these prohibitions can result in serious or fatal injury.

**International Symbols**

| Symbol | Description                       | Symbol | Description          |
|--------|-----------------------------------|--------|----------------------|
|        | Read and understand Owners Manual |        | Fuel and oil mixture |
|        | Wear eye, ear and head protection |        | Finger severing      |
|        | Emergency Stop                    |        | Hot Surface          |

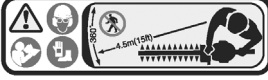
| Symbol  | Description   | Symbol  | Description  |
|---|---|---|--|
|    | Wear hand and foot protection. Use two handed                                 |    | DO NOT smoke near fuel   |
|    | Choke Control "COLD START" Position (Choke Closed)                            |    | Ignition ON / OFF  |
|    | Choke Control "RUN" Position (Choke Open)                                     |    | Do not operate without guards in place.                          |
|    | Carburetor Adjustment - Low speed mixture                                     |    | Carburetor Adjustment - High speed mixture                       |
|    | Safety/Alert  |    | Carburetor Adjustment - Idle speed                               |
|    | Avoid all power lines. This unit is not insulated against electrical current. |    | Do not operate closer than 15 M (50 ft.) from electrical hazard. |
|   | Plan retreat path from falling objects  |   | Primer Bulb  |
|  | DO NOT allow flames or sparks near fuel                                       |  | Wear slip resistant footwear                                     |
|  |   | Keep bystanders at least 4.5 meters (15 ft.) away.                                  |  |



**LOOK BEFORE YOU PUMP!**

Ethanol Percentage

|          |                       |
|----------|-----------------------|
| 0% - 10% | 15% - 30% - 50% - 85% |
|----------|-----------------------|

**USE E10 <sup>OR</sup> LESS FUEL**

Do not use any fuel containing greater than 10 percent ethanol (E10) in this equipment. It may cause damage or failure and is prohibited by Federal Law.

For Details, see the "Fuel" Section of your Operators Manual

### Personal Condition and Safety Equipment

#### **WARNING**

*Cancer and Reproductive Harm*  
[www.P65Warnings.ca.gov](http://www.P65Warnings.ca.gov)

#### **WARNING**



*The muffler or catalytic muffler and surrounding cover may become extremely hot. Always keep clear of exhaust and muffler area, otherwise serious personal injury may occur.*

#### **WARNING**

*Users of this product risk injury to themselves and others if the unit is used improperly and/or safety precautions are not followed. Proper clothing and safety gear must be worn when operating unit.*

### Physical Condition

Your judgment and physical dexterity may not be good:

- If you are tired or sick
- If you are taking medication
- If you have taken alcohol or drugs

Operate unit only if you are physically and mentally well.

## Eye Protection

### **WARNING**

- ◆ **Eye protection that meets ANSI Z87.1 or CE requirements must be worn whenever you operate the unit.**
- ◆ **For additional safety, a full-face shield may be worn over safety glasses or goggles to provide protection from sharp branches or flying debris.**

## Hand Protection

Wear sturdy, no-slip, rubber work gloves to improve your grip on the handles. Gloves also provide protection against cuts and scratches, cold environments, and reduce the transmission of machine vibration to your hands.

## Hearing/Ear Protection

ECHO recommends wearing personal protection whenever unit is used.

## Breathing Protection

Operators who are sensitive to dust or other common airborne allergens may need to wear a dust mask to prevent inhaling these materials while operating unit. Dust masks can provide protection against dust, plant debris, and other plant matter such as pollen. Make sure the mask does not impair your vision, and replace the mask as needed to prevent air restrictions.

## Proper Clothing

Wear snug-fitting, durable clothing:

- Pants should have long legs, shirts should have long sleeves.
- **DO NOT WEAR SHORTS.**
- **DO NOT WEAR TIES, SCARVES, JEWELRY,** or clothing with loose or hanging items that could become entangled in moving parts or surrounding growth.
- Keep clothing buttoned or zipped, and keep shirt tails tucked in.
- Wear sturdy work shoes with nonskid rubber soles:
- **DO NOT WEAR OPEN TOED SHOES.**
- **DO NOT OPERATE UNIT BAREFOOTED.**

Keep long hair away from engine and air intake. Retain hair with cap or net.



Heavy protective clothing can increase operator fatigue, which may lead to heat stroke. Schedule heavy work for early morning or late afternoon hours when temperatures are cooler.

 **WARNING**

***The components of this machine generate an electromagnetic field during operation, which may interfere with some pacemakers. To reduce the risk of serious or fatal injury, persons with pacemakers should consult with their physician and the pacemaker manufacturer before operating this machine. In the absence of such information, ECHO does not recommend the use of this machine by anyone who has a pacemaker.***

**Extended Operation / Extreme Conditions**

 **CAUTION**

***Prolonged exposure to cold and/or vibration may result in injury. Read and follow all safety and operation instructions to minimize risk of injury. Failure to follow instructions may result in painful wrist/hand/arm injuries.***

It is believed that a condition called Raynaud’s Phenomenon, which affects the fingers of certain individuals, may be brought about by exposure to vibration and cold. Exposure to vibration and cold may cause tingling and burning sensations, followed by loss of color and numbness in the fingers. The following precautions are strongly recommended, because the minimum exposure, which might trigger the ailment, is unknown.

- Keep your body warm, especially the head, neck, feet, ankles, hands, and wrists.
- Maintain good blood circulation by performing vigorous arm exercises during frequent work breaks, and also by not smoking.
- Limit the hours of operation. Try to fill each day with jobs where operating the unit or other hand-held power equipment is not required.
- If you experience discomfort, redness, and swelling of the fingers followed by whitening and loss of feeling, consult your physician before further exposing yourself to cold and vibration.

## Repetitive Stress Injuries (RSI)

It is believed that overusing the muscles and tendons of the fingers, hands, arms, and shoulders may cause soreness, swelling, numbness, weakness, and extreme pain in those areas. Certain repetitive hand activities may put you at a high risk for developing a Repetitive Stress Injury (RSI). An extreme RSI condition is Carpal Tunnel Syndrome (CTS), which could occur when your wrist swells and squeezes a vital nerve that runs through the area. Some believe that prolonged exposure to vibration may contribute to CTS. CTS can cause severe pain for months or even years.

To reduce the risk of RSI/CTS, do the following:

- Avoid using your wrist in a bent, extended, or twisted position. Instead try to maintain a straight wrist position. Also, when grasping, use your whole hand, not just the thumb and index finger.
  - Take periodic breaks to minimize repetition and rest your hands.
  - Reduce the speed and force with which you do the repetitive movement.
- 
- Do exercises to strengthen the hand and arm muscles.
  - Immediately stop using all power equipment and consult a doctor if you feel tingling, numbness, or pain in the fingers, hands, wrists, or arms. The sooner RSI/CTS is diagnosed, the more likely permanent nerve and muscle damage can be prevented.

## DANGER

***All over head electrical conductors and communications wires can have electricity flow with high voltages. This unit is not insulated against electrical current. Never touch wires directly or indirectly, otherwise serious injury or death may result.***

 **DANGER**

***Do not operate this product indoors or in inadequately ventilated areas. Engine exhaust contains poisonous emissions and can cause serious injury or death.***

**Read the Manuals**

- Provide all users of this equipment with the Operator’s Manual for instructions on Safe Operation.

**Clear the Work Area**

- Spectators and fellow workers must be warned, and children and animals prevented from coming nearer than 15 m (50 ft.) while the unit is in use.

**Keep a Firm Grip**

- Always hold throttle handle and support handle with thumbs and fingers tightly encircling the handles.

**Keep a Solid Stance**

- Maintain footing and balance at all times. Do not stand on slippery, uneven or unstable surfaces. Do not work in odd positions or on ladders. Do not over reach.

**Avoid Hot Surfaces**

- Keep exhaust area clear of flammable debris. Avoid contact during and immediately after operation.



 **WARNING**

***Never perform blade maintenance procedures while engine is running.***

## Equipment

 **WARNING**

*Use only ECHO attachments. Serious injury may result from the use of a non-approved attachment combination. ECHO, INC. will not be responsible for the failure of cutting devices, attachments or accessories which have not been tested and approved by ECHO, INC. Read and comply with all safety instructions listed in this manual and safety manual.*

- ◆ Check unit for loose or missing nuts, bolts, and screws. Tighten and/or replace as needed.
- ◆ Check that the cutting attachment is firmly attached and in safe operating condition. Dull, loose or damaged blades should not be used.

 **WARNING**

*Moving parts can amputate fingers or cause severe injuries. Keep hands, clothing and loose objects away from all openings.*

- ◆ *ALWAYS stop engine, disconnect spark plug, and make sure all moving parts have come to a complete stop before removing obstructions, clearing debris, or servicing unit.*
- ◆ *DO NOT start or operate unit unless all guards and protective covers are properly assembled to unit.*
- ◆ *NEVER reach into any opening while the engine is running. Moving parts may not be visible through openings.*

 **WARNING**

*Periodically check fuel system (fuel lines, vent, grommet, fuel tank, and fuel cap) for leaks especially if the unit is dropped. If damage or leaks are found, do not use unit, otherwise serious personal injury or property damage may occur. Have unit repaired by an authorized servicing dealer before using.*

## EMISSION CONTROL (EXHAUST & EVAPORATIVE)

### CARB And EPA Emissions Control Information

The emission control system for the engine is EM (engine modification) and, if the second to last character of the Engine Family on the Emission Control Information label (sample below) is "B", "C", "K", or "T", the emission control system is EM and TWC (3-way catalyst). The fuel tank/fuel line emission control system is EVAP (evaporative emissions). Evaporative emissions for California models are only applicable to fuel tanks and fuel feed lines.

**EMISSION CONTROL INFORMATION**  
 ENGINE FAMILY: E2ERHS.0214EQ DISPLACEMENT: 21.2cc  
 EMISSION COMPLIANCE PERIOD: 50Hours  
 THIS ENGINE MEETS 2013 U.S. EPA EXH/EVP & CALIFORNIA  
 EXH/EVP EMISSION REGULATIONS FOR S.O.R.E. REFER TO OWNER'S  
 MANUAL FOR MAINTENANCE SPECIFICATIONS AND ADJUSTMENTS.  
**YAMABIKO CORP. MMM/YYYY** 

**An Emission Control Label** is located on the engine. (This is an **EXAMPLE ONLY**, information on label varies by engine FAMILY).

### Product Emission Durability (Emission Compliance Period)

**EMISSION CONTROL INFORMATION**  
 ENGINE FAMILY: CEHXS.0214KL DISPLACEMENT: 21.2cc  
 EMISSION COMPLIANCE PERIOD: 300Hours  
 THIS ENGINE MEETS 2012 U.S. EPA EXH/EVP & CALIFORNIA  
 EXH/EVP EMISSION REGULATIONS FOR S.O.R.E. REFER TO OWNER'S  
 MANUAL FOR MAINTENANCE SPECIFICATIONS AND ADJUSTMENTS.  
**YAMABIKO CORP. MMM/YYYY** 

The 50 or 300 hour emission compliance period is the time span selected by the manufacturer certifying the engine emissions output meets applicable emissions regulations, provided that approved maintenance procedures are followed as listed in the Maintenance Section of this manual.

DESCRIPTION

Locate the safety decal(s) on your unit. Make sure the decal(s) is legible and that you understand and follow the instructions on it. If a decal cannot be read, a new one can be ordered from your ECHO dealer. Safety label is for example only. Your label may appear slightly different.

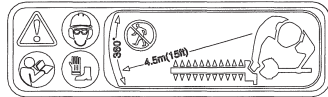
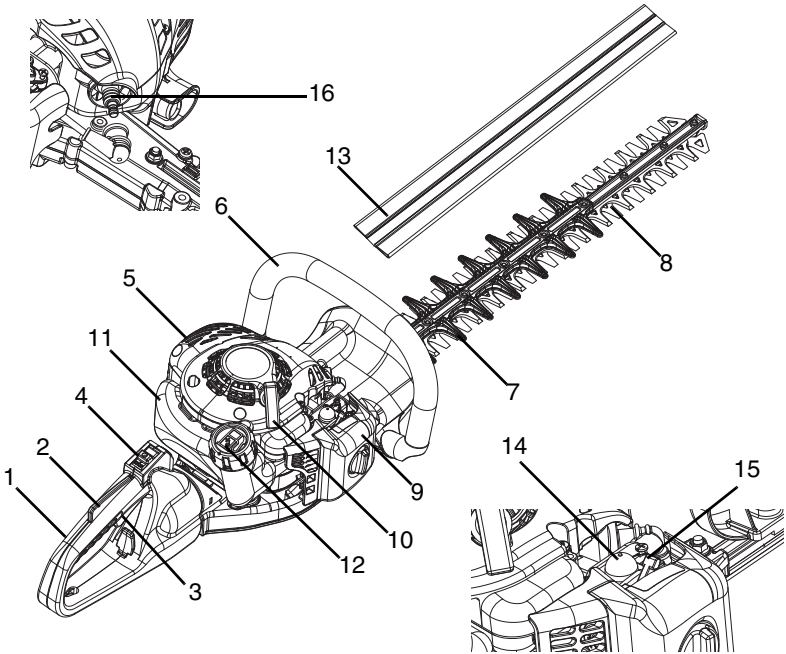

- 1. Throttle Handle
- 2. Throttle Trigger Lockout
- 3. Throttle Trigger
- 4. Stop Switch
- 5. Spark Arrestor Muffler Or Spark Arrestor Muffler With Catalyst
- 6. Support Handle
- 7. Blade Guard

8. Blades
9. Air Filter
10. Recoil Starter Handle
11. Fuel Tank
12. Fuel Tank Cap
13. Blade Cover
14. Purge Bulb
15. Choke
16. Spark Plug

## **CONTENTS**

---

The ECHO product you purchased has been factory pre-assembled for your convenience. Due to packaging restrictions, some assembly may be necessary.

After opening the carton, check for damage. Immediately notify your retailer or ECHO Dealer of damaged or missing parts. Use the contents list to check for missing parts.

- 1 Hedge Trimmer Assembly
- 1 Operator's Manual
- 1 Warranty Statement
- 1 Blade Cover

---

## ASSEMBLY

---

This model is factory assembled.

---

## OPERATION

---

### **WARNING**

*Moving parts can amputate fingers or cause severe injuries. Keep hands, clothing and loose objects away from all openings. Always stop engine, disconnect spark plug, and make sure all moving parts have come to a complete stop before removing obstructions, clearing debris, or servicing unit.*

### **WARNING**

*Engine exhaust IS HOT, and contains Carbon Monoxide (CO), a poison gas. Breathing CO can cause unconsciousness, serious injury, or death. Exhaust can cause serious burns. ALWAYS position unit so that exhaust is directed away from your face and body.*

### **WARNING**

*Operation of this equipment may create sparks that can start fires around dry vegetation. This unit is equipped with a spark arrestor to prevent discharge of hot particles from the engine. Metal cutters can also create sparks if the cutter strikes rocks, metal, or other hard objects. Contact local fire authorities for laws or regulations regarding fire prevention requirements.*



## Fuel

### **WARNING**

***Diesel fuels and alternative fuels, such as E-15 (15% ethanol), E -85 (85% ethanol) or any fuels not meeting ECHO requirements are NOT approved for use in ECHO 2-stroke gasoline engines. Use of diesel or alternative fuels may cause performance problems, loss of power, overheating, fuel vapor lock, and unintended machine operation, including, but not limited to, improper clutch engagement. Diesel or alternative fuels may also cause premature deterioration of fuel lines, gaskets, carburetors and other engine components.***

### Fuel Requirements

**Gasoline** - Use 89 Octane [R+M/2] (mid grade or higher) gasoline known to be good quality. Gasoline may contain up to 10% Ethanol (grain alcohol) or 15% MTBE (methyl tertiary-butyl ether). Gasoline containing methanol (wood alcohol) is **NOT** approved. Use of ECHO branded fuel is recommended to extend engine life in all air-cooled 2-stroke and 2/4-stroke hybrid engines.

**Two Stroke Oil** - A two-stroke engine oil, such as ECHO branded 2-stroke oils, meeting ISO-L-EGD (ISO/CD 13738) and J.A.S.O. FD Standards must be used. ECHO branded 2-stroke oils meet these standards. Engine problems due to inadequate lubrication caused by failure to use an ISO-L-EGD (ISO/CD 13738) and J.A.S.O. M345-FD certified oil will void the two-stroke engine warranty.

### **WARNING**

***2-Stroke engine oil contains petroleum distillates and other additives that may be harmful if swallowed. Heated oil can release vapors that can cause flash fire, or ignite with explosive force. Read and follow the oil manufacturer's instructions, and observe all safety warnings and precautions for handling flammable liquids. For more detailed safety and first aid information, visit [www.echo-usa.com](http://www.echo-usa.com) for a copy of the Material Safety Data Sheet.***

- ◆ **KEEP OUT OF REACH OF CHILDREN.**
- ◆ **If swallowed, do not induce vomiting. CALL PHYSICIAN OR A POISON CONTROL CENTER IMMEDIATELY.**
- ◆ **WEAR SAFETY GLASSES when mixing or handling.**

- ◆ AVOID repeated or prolonged skin contact.
- ◆ AVOID inhaling oil mists or vapors.

## NOTICE

*ECHO branded 2-stroke oils may be mixed at 50:1 ratio for application in all ECHO engines sold in the past regardless of ratio specified in those manuals.*

### Handling Fuel

## DANGER

***Fuel is VERY flammable. Use extreme care when mixing, storing or handling, or serious personal injury may result.***

- ◆ ***Use an approved fuel container. Mark fuel containers as containing 2-stroke mixture fuel.***
- ◆ ***DO NOT smoke near fuel.***
- ◆ ***DO NOT allow flames or sparks near fuel.***
- ◆ ***Fuel tanks/cans may be under pressure. Always loosen fuel caps slowly allowing pressure to equalize.***
- ◆ ***NEVER refuel a unit when the engine is HOT or RUNNING!***
- ◆ ***DO NOT fill fuel tanks indoors. ALWAYS fill fuel tanks outdoors over bare ground.***
- ◆ ***DO NOT overfill fuel tank. Wipe up spills immediately.***
- ◆ ***Securely tighten fuel tank cap and close fuel container after refueling.***
- ◆ ***Inspect for fuel leakage. If fuel leakage is found, do not start or operate unit until leakage is repaired.***
- ◆ ***Move at least 3 m (10 ft.) from refueling location before starting the engine.***

## DANGER

***Gasoline vapor is heavier than air, and can travel along the ground to nearby sources of ignition such as electrical motors, pilot lights, and hot or running engines. Vapors ignited by an ignition source can flash back to the fuel container, resulting in an explosion, fire, serious or fatal injuries, and extensive property damage.***

**Mixing Instructions**

1. Fill an approved fuel container with half of the required amount of gasoline.
2. Add the proper amount of 2-stroke oil to gasoline.
3. Close container and shake to mix oil with gasoline.
4. Add remaining gasoline, close fuel container, and remix.

| Fuel to Oil Mix – 50:1 Ratio |        |        |     |
|------------------------------|--------|--------|-----|
| US                           |        | Metric |     |
| Gas                          | Oil    | Gas    | Oil |
| gal.                         | fl.oz. | L      | cc  |
| 1                            | 2.6    | 5      | 100 |
| 2                            | 5.2    | 10     | 200 |
| 5                            | 13     | 25     | 500 |

**NOTICE**

*Spilled fuel is a leading cause of hydrocarbon emissions. Some localities may require the use of automatic fuel shut-off containers to reduce fuel spillage.*

**Storage** - Fuel storage laws vary by locality. Contact your local government for the laws affecting your area. As a precaution, store fuel in an approved, airtight container. Store in a well-ventilated, unoccupied building, away from sparks and flames.

- Empty the fuel tank prior to storing the unit. Return unused fuel to an approved fuel storage container.

**NOTICE**

*Stored fuel ages. Do not mix more fuel than you expect to use in 30 days, 90 days when a fuel stabilizer is added.*

**NOTICE**

*Stored two-stroke fuel may separate. ALWAYS shake fuel container thoroughly before each use.*

**NOTICE**

*Used oil and gasoline, and soiled towels are hazardous waste materials. Disposal laws vary by locality.*

## Starting Cold Engine

### **WARNING**

**Hedge Trimmer blades are very sharp. Touching them may lead to severe personal injury. Avoid touching blades whenever possible, and always wear gloves to protect hands.**

Note: The blade cover is used for transportation and storage.  
Remove blade cover before using the unit.

1. *Stop Switch*

Move stop switch (A) away from the STOP position.

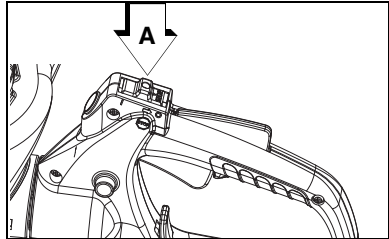

2. *Choke*

Move choke (B) to COLD START (↔) (closed) position.

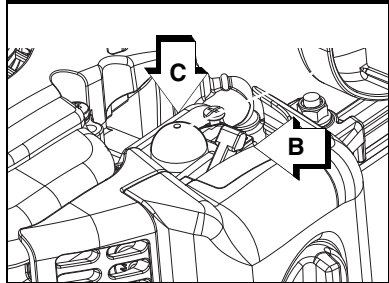

3. *Purge Bulb*

Pump purge bulb (C) until fuel is visible and flows freely in the clear fuel tank return line. Pump bulb an additional 4 or 5 times.

4. *Recoil Starter*

Lay the unit on a flat, clear area. Grip the support handle securely with one hand, and pull the recoil starter handle (D) until engine fires (or 5 pulls maximum).

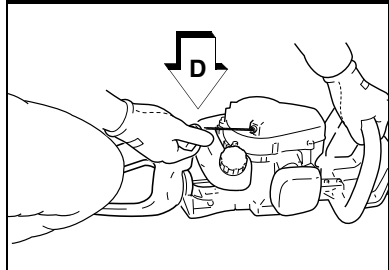

5. *Choke*

After engine fires (or 5 pulls), move choke (B) to the RUN (↑ ↓) (open) position. Restart engine if necessary and allow unit to warm up at idle for several minutes.

Note: If engine does not start with choke in "RUN" position after 5 pulls, repeat instructions 2 - 5.

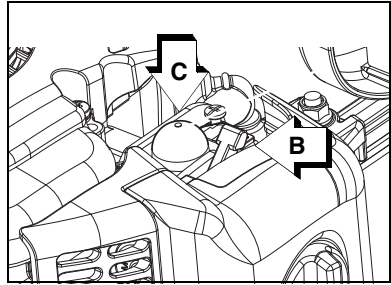

**! WARNING**

***The blades must not move at idle, otherwise serious personal injury may result. Periodic carburetor adjustment may be necessary to assure blades do not move at idle. If blades move, readjust carburetor according to "Carburetor Adjustment" instructions in this manual or see your ECHO Dealer.***

6. *Throttle Trigger*

After engine warm-up, grip the throttle handle and support handle. Depress the throttle trigger lockout (E), and gradually depress throttle trigger (F) to increase engine RPM to operating speed.

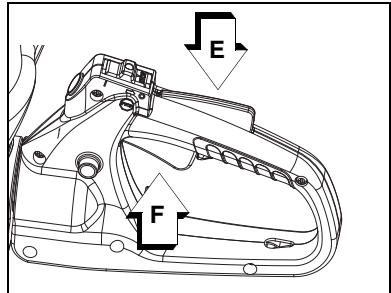

**Starting Warm Engine**

The starting procedure is the same as Cold Start except DO NOT close the choke.

**! WARNING**

***The blades must not move at idle, otherwise serious personal injury may result. Periodic carburetor adjustment may be necessary to assure blades do not move at idle. If blades move, readjust carburetor according to "Carburetor Adjustment" instructions in this manual or see your ECHO Dealer.***

1. *Stop Switch*

Move stop switch (A) away from the STOP position.

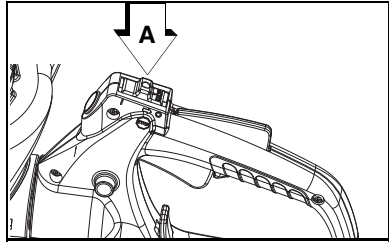

2. *Purge Bulb*

Pump purge bulb (C) until fuel is visible and flows freely in the clear fuel tank return line. Pump bulb an additional 4 or 5 times.

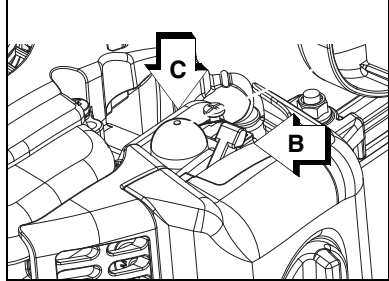

3. *Recoil Starter*

Place the unit on a flat, clear area. Grip the support handle securely with one hand, and pull the recoil starter handle (D) until engine starts.

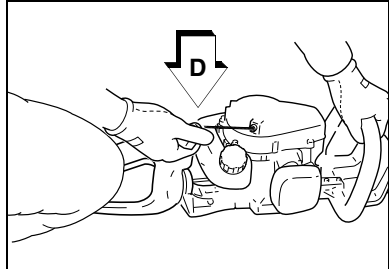

Note: If engine does not start after 5 pulls, use Cold Start Procedure.

**Stopping Engine**

1. *Throttle*

Release throttle trigger (F) and allow engine to return to idle before shutting off engine.

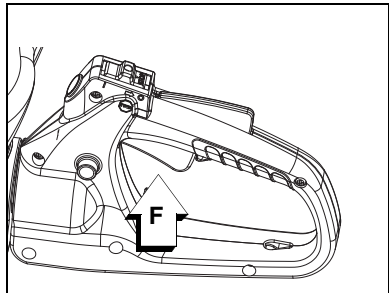

2. *Stop Switch*

Move stop switch (A) to STOP position.

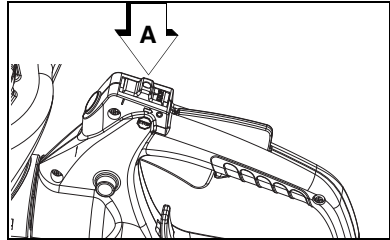

**! WARNING**

***If engine does not stop when stop switch is moved to STOP position, close choke - COLD START position - to stall engine. Have your ECHO dealer repair stop switch before using unit again.***

**Rotating operation**

This model is equipped with a rotating throttle handle that can be turned 90° to either side of vertical operating position to help reduce operator fatigue and improve precision trimming.

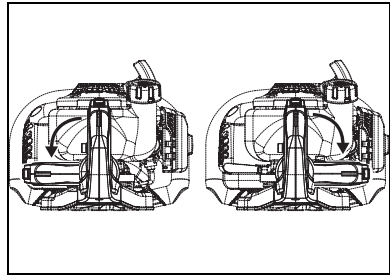

**! WARNING**

***Always stop the engine before rotating the handle! Failure to do so could result in serious injury.***

**To operate**

- 1. Fully release throttle trigger.
- 2. Push handle release lever.
- 3. Rotate the handle 90° in the desired direction and release the lever. Make sure that the handle is fully locked into position before use.

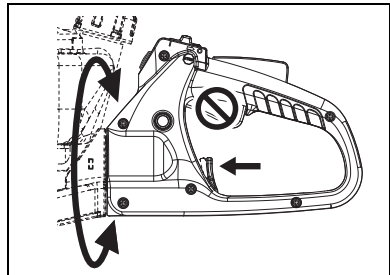

Note: The throttle trigger will not operate when the throttle handle is not fully locked into position.

**Hedge Trimming**

**! WARNING**

***Hedge Trimmer blades are very sharp. Touching them may lead to severe personal injury. Avoid touching blades whenever possible, and always wear gloves to protect hands.***

1. Always grip support handle with right hand, and throttle handle with left hand.
2. Hold trimmer firmly and squeeze throttle trigger to accelerate engine.
3. Tilt trimmer so cutting teeth are angled slightly toward the hedge or shrub and proceed to cut.

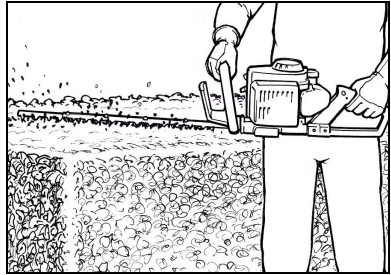

**! WARNING**

***Never remove hands from unit when blades are moving.***

**! WARNING**

***The engine continues running even when the blades have stopped due to an obstruction. If this occurs, stop the engine, disconnect ignition cable and remove the obstruction.***

**MAINTENANCE**

**! WARNING**

***Moving parts can amputate fingers or cause severe injuries. Keep hands, clothing and loose objects away from all openings. Always stop engine, disconnect spark plug, and make sure all moving parts have come to a complete stop before removing obstructions, clearing debris, or servicing unit. Allow unit to cool before performing service. Wear gloves to protect hands from sharp edges and hot surfaces.***



**WARNING**

***Operating a poorly maintained unit can result in serious injuries to operator or bystanders. Always follow all maintenance instructions as written, otherwise serious personal injury may result.***

Your unit is designed to provide many hours of trouble free service. Regular scheduled maintenance will help your unit achieve that goal. If you are unsure or are not equipped with the necessary tools, we recommend that you take your unit to a Servicing Dealer for maintenance. To help you decide whether you want to DO-IT-YOURSELF or have the Dealer do it, each maintenance task has been graded. If the task is not listed, see your Dealer for repairs.

## Skill Levels

**Level 1** = Easy to do. Common tools may be required.

**Level 2** = Moderate difficulty. Some specialized tools may be required.

**Level 3** = See your dealer.

Click [HERE](#) or go to <http://www.echo-usa.com/products/maintenance-kit>

or

[HERE](https://www.shindaiwa-usa.com/you-can.aspx) <https://www.shindaiwa-usa.com/you-can.aspx>

For information about maintenance kits.

## Maintenance Intervals

| COMPONENT/SYSTEM           | MAINTENANCE PROCEDURE      | REQUIRED SKILL LEVEL |
|----------------------------|----------------------------|----------------------|
| <b>Daily or Before Use</b> |                            |                      |
| Air Filter                 | Inspect/Clean *            | 1                    |
| Choke Shutter              |                            |                      |
| Fuel System                |                            |                      |
| Cooling System             | Inspect/Clean <sup>3</sup> | 2                    |
| Recoil Starter Rope        | Inspect/Clean *            | 1                    |
| Screws/Nuts/Bolts          | Inspect/Tighten/Replace *  |                      |
| Blades                     | Inspect/Clean <sup>2</sup> |                      |
| <b>Every Refuel</b>        |                            |                      |

| COMPONENT/SYSTEM       | MAINTENANCE PROCEDURE   | REQUIRED SKILL LEVEL |
|------------------------|-------------------------|----------------------|
| Fuel System            | Inspect <sup>3</sup>    | 1                    |
| <b>Three Months</b>    |                         |                      |
| Air Filter             | Replace *               | 1                    |
| Fuel Filter            | Inspect *               |                      |
| Fuel Cap Gasket        |                         |                      |
| Spark Plug             | Inspect/Clean/Replace * | 1                    |
| Muffler Spark Arrestor |                         |                      |
| Cylinder Exhaust Port  | Inspect/Clean/De-carbon | 2                    |
| Gear Housing           | Grease <sup>1</sup>     |                      |
| <b>Yearly</b>          |                         |                      |
| Fuel Filter            | Inspect/Replace *       | 1                    |
| Fuel Cap Gasket        | Replace *               |                      |

**IMPORTANT NOTE** - Time intervals shown are maximum. Actual use and your experience will determine the frequency of required maintenance.

**MAINTENANCE PROCEDURE NOTES:**

1 Apply lithium based grease every 25 hours of use.

2 Inspect blade, and clean and sharpen as needed. Lubricate blades periodically during use.

3 Low evaporative fuel tanks DO NOT require regular maintenance to maintain emission integrity.

\* Replacement is recommended based on the finding of damage or wear during inspection.

**Air Filter**

**Level 1.**

Parts Required: AIR FILTER

1. Close choke (A)(COLD START [] position). This prevents dirt from entering the carburetor throat when the air filter is removed. Brush accumulated dirt from air cleaner area.

2. Remove air filter cover. Brush dirt from inside cover.
3. Replace filter if it is damaged, fuel soaked, very dirty, or the rubber sealing edges are deformed.
  - Lightly brush debris from filter.
  - Soak heavily soiled filters in water/detergent solution to loosen dirt, then brush lightly.
  - Rinse with clean water and allow to dry completely before reuse.
4. Install air filter in air filter case.
5. Install air filter cover.

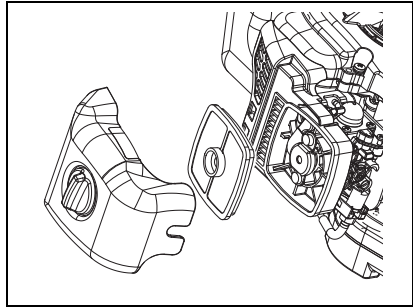

## Fuel Filter

### Level 1.

Parts Required: FUEL FILTER

## ! DANGER

**Fuel is VERY flammable. Use extreme care when mixing, storing or handling, or serious personal injury may result.**

1. Use a clean rag to remove loose dirt from around fuel cap and empty fuel tank.
2. Carefully pull the fuel line and filter from the tank and install a new filter.

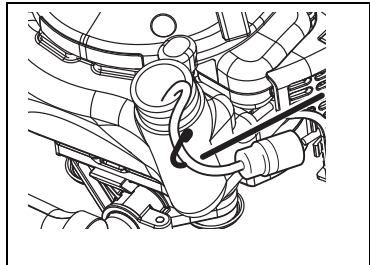

Note: Federal EPA regulations require all model year 2012 and later gasoline powered engines produced for sale in the United States to be equipped with a special low permeation fuel supply hose between the carburetor and fuel tank. When servicing model year 2012 and later equipment, only fuel supply hoses certified by EPA can be used to replace the original equipment supply hose. Fines up to \$37,500 may be enforced for using an un-certified replacement part.

## Spark Plug

### Level 2.

Parts Required: Spark Plug

## NOTICE

*Use only NGK BPMPR-8Y otherwise severe engine damage may occur.*

1. Remove spark plug and check for fouling, worn and rounded center electrode.
2. Clean the plug or replace with a new one. DO NOT sand blast to clean. Remaining sand will damage engine.
3. Adjust spark plug gap by bending outer electrode.
4. Tighten spark plug to 150-170 kgf • cm (130-150 in • lbf).

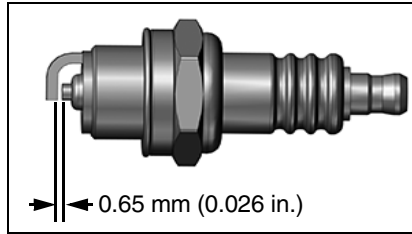

## Cooling System

### Level 2.

## NOTICE

*To maintain proper engine operating temperatures, cooling air must pass freely through the cylinder fin area. This flow of air carries combustion heat away from the engine.*

Overheating and engine seizure can occur when:

- Air intakes are blocked, preventing cooling air from reaching the cylinder.
- Dust and grass build up on the outside of the cylinder. This build up insulates the engine and prevents the heat from leaving.

Removal of cooling passage blockages or cleaning of cooling fins is considered "Normal Maintenance." Any failure attributed to lack of maintenance is not warranted.

1. Remove spark plug lead.
2. Remove engine cover (A).
3. Use brush to remove dirt from the cylinder fins.

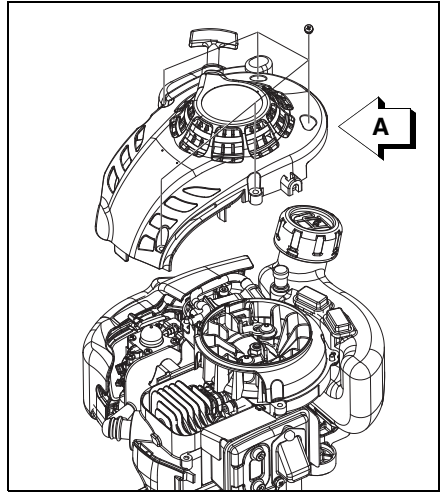

## NOTICE

*DO NOT use a metal scraper to remove dirt from the cylinder fins.*

4. Assemble components in reverse order.

## Exhaust System

### Spark Arrestor Screen

Level 2.

Parts Required: Spark Arrestor Screen, Gasket

1. Remove spark plug lead.
2. Remove muffler cover (B).
3. Place piston at Top Dead Center (TDC) to prevent carbon/dirt from entering cylinder.
4. Remove exhaust guide (C), gasket (D), and screen (E) from muffler body.
5. Clean carbon deposits from muffler components.

**Note:** When cleaning carbon deposits, be careful not to damage the catalytic element inside muffler.

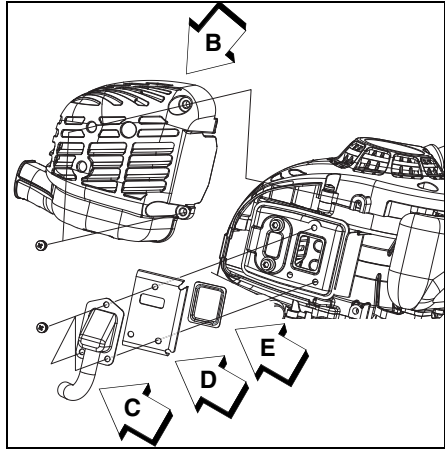

6. Replace screen if it is cracked, plugged, or has holes burned through.
7. Assemble components in reverse order.

**Exhaust Port Cleaning**

**Level 2.**

Parts Required: As needed: Heat Shield

1. Remove spark plug lead from spark plug, and remove muffler cover.
2. Place piston at top dead center. Remove muffler and heat shield.

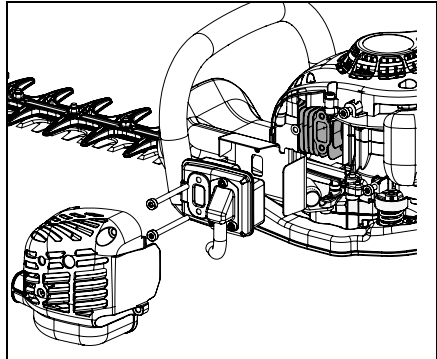

3. Use a wood or plastic scraping tool to clean deposits from cylinder exhaust port.

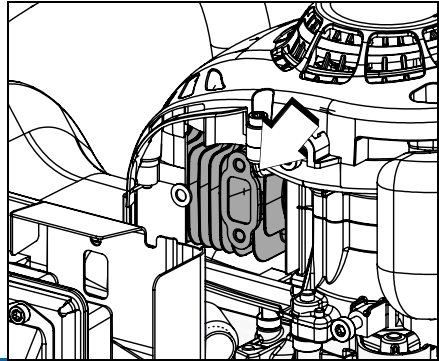

**NOTICE**

*Never use a metal tool to scrape carbon from the exhaust port. Do not scratch the cylinder or piston when cleaning the exhaust port. Do not allow carbon particles to enter the cylinder.*

4. Inspect heat shield, and replace if damaged.
5. Install heat shield and muffler.
6. Tighten muffler mounting bolts (or nuts) to 90-110 kgf•cm (80-95 in•lbf).
7. Install engine cover and attach spark plug lead.
8. Start engine, and warm to operating temperature.
9. Stop engine, and re-tighten mounting bolts (or nuts) to specifications.

**Carburetor Adjustment**

**⚠ WARNING**

***The blades must not move at idle, otherwise serious personal injury may result. Periodic carburetor adjustment may be necessary to assure blades do not move at idle.***

***If blades move, readjust carburetor according to these instructions, or see your ECHO Dealer.***

**Engine Break-In**

New engines must be operated a minimum duration of two tanks of fuel break-in before carburetor adjustments can be made. During the break-in period your engine performance will increase and exhaust emissions will stabilize. Idle speed can be adjusted as required.

**High Altitude Operation**

This engine has been factory adjusted to maintain satisfactory starting, emission, and durability performance up to 1,100 feet above sea level (ASL) (96.0 kPa). To maintain proper engine operation above 1,100 feet ASL the carburetor may need to be adjusted by an authorized ECHO service dealer.

**NOTICE**

*If the engine is adjusted for operation above 1,100 feet ASL, the carburetor must be re-adjusted when operating the engine below 1,100 feet ASL, otherwise severe engine damage may result.*

**Level 2.**

Note: Every unit is run at the factory and the carburetor is set in compliance with emission regulations. Carburetor adjustments, other than idle speed, must be performed by an authorized ECHO dealer.

1. Check idle speed and reset if necessary. If a tachometer is available, idle speed screw (H) should be set to the specifications found on "Specifications" page of this manual. Turn idle screw (H) clockwise to increase idle speed; counter clockwise to decrease idle speed.

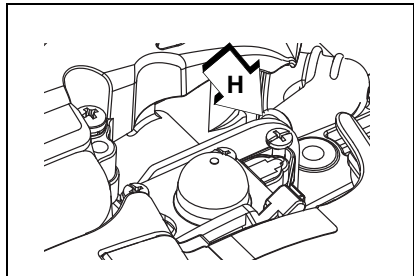

**! WARNING**

***When carburetor adjustment is completed, the cutting attachment should not move at idle, otherwise serious personal injury may result.***

**Lubrication**

**Blades**

**Level 1.**

Parts Required: Echo RedArmor™ Blade Cleaner & Lubricant, or 20W Engine Oil (blade lubrication), 50-50 mixture of kerosene and 20W oil (blade cleaning)



**! WARNING**

**Hedge Trimmer blades are very sharp. Touching them may lead to severe personal injury. Avoid touching blades whenever possible, and always wear gloves to protect hands.**

1. Move stop switch to stop position.
2. Disconnect spark plug wire from spark plug.
3. Brush loose debris from blade and coat both sides of blade with the 50- 50 cleaning mixture.
4. Allow cleaning mixture to soften the remaining gummy residue then wipe it from the blade.
5. Apply clean oil to the entire length of the blade. Be certain the blade bolts are lubricated.
6. Wipe excess oil from the blade before putting the unit back in service.

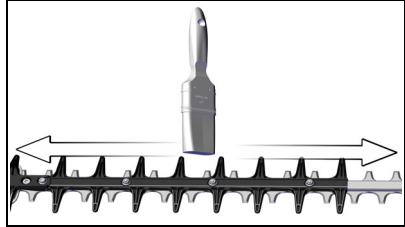

**Gear Box**

**Level 1.**

Parts Required: Lithium Based Grease.

1. Clean dirt from the grease fitting (A) and grommet (B).
2. Do not force grease. Too much pressure will force grease past seals and cause damage. Apply 1-2 pumps of grease every 20 hours of operation.

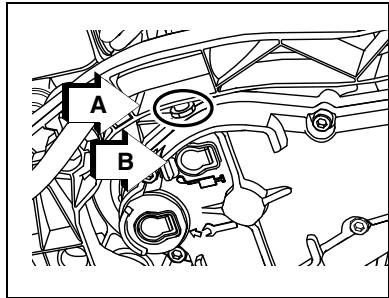

3. Remove the grommet next to the grease icon then add grease as illustrated.
4. Reinstall the grommet securely in the hole otherwise, it may become lost.

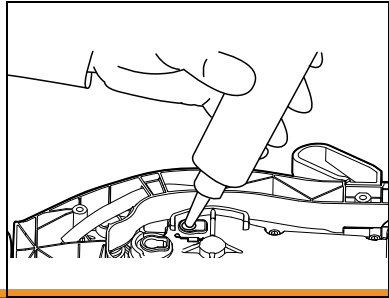

**Blades**

**! WARNING**

***Hedge trimmer blades are very sharp, touching them may lead to severe personal injury. Use long hex wrenches and sockets with extensions when tightening blade screws and blade lock nuts to keep hands at a safe distance from sharp blades.***

**NOTICE**

*Blades should only be removed and reinstalled by an authorized servicing dealer, otherwise premature wear or internal damage may occur.*

**Sharpening**

**Level 2.**

**NOTICE**

*If a power grinder is used DO NOT allow blade to over heat.*

1. Move stop switch to STOP position.
2. Disconnect spark plug wire.
3. Remove blade guard.
4. Slide blades to allow file clearance using slots (A) on bottom of blade. Do not pry against cutting edges.
5. File each edge carefully. Follow the original shape of the blade.
6. Install blade guard.

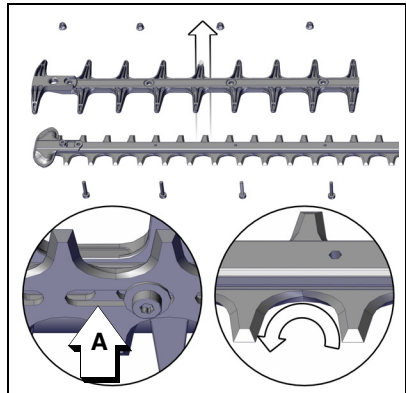

# NOTICE

Use new lock nuts each time blade guard is installed. See dealer for correct nuts.

- 7. Lubricate blades (see “Lubrication”).
- 8. Connect spark plug wire.

## Adjustment

### Level 2.

# NOTICE

Locking ability of hedge trimmer blade lock nuts will diminish each time they are removed. Replace if turning resistance is not felt when installing lock nuts.

- 1. Tighten blade screws securely.
- 2. Hold blade screws (A) to prevent turning, and tighten lock nuts (B).

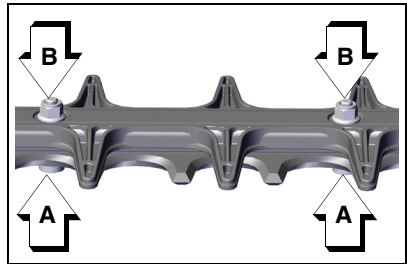

## TROUBLESHOOTING

| ENGINE PROBLEM TROUBLESHOOTING CHART                               |                           |                                 |   |   |
|--|---------------------------|---------------------------------|---|---|
| Problem  | Check                     | Status                          | Cause   | Remedy  |
| Engine starts hard<br>or<br>Engine does not start                  | Fuel at carburetor        | No fuel at carburetor           | Fuel strainer or fuel line obstructed                                   | Clean or replace<br>See your dealer   |
|  | Fuel at cylinder          | No fuel at cylinder             | Carburetor  | See your dealer   |
|  |                           | Muffler wet with fuel           | Fuel mixture too rich   | OPEN choke<br>Clean or replace air filter<br>Adjust carburetor<br>See your dealer |
|  | Spark at end of plug wire | No spark                        | Stop switch OFF - Electrical problem - Interlock switch                 | Turn switch to ON<br>See your dealer  |
|  | Spark at plug             |                                 | Incorrect gap - Covered with carbon - Fouled with fuel - Plug defective | Adjust to 0.65mm (0.026 in.)<br>Clean or replace plug                             |
| Engine runs, but dies<br>or<br>Engine does not accelerate properly | Air filter                | Air filter dirty                | Normal wear   | Clean or replace  |
|  | Fuel filter               | Fuel filter dirty               | Contaminants or residue in fuel   | Replace filter or replace fuel  |
|  | Fuel vent                 | Fuel vent plugged               | Contaminated fuel   | Clean or replace  |
|  | Spark plug                | Plug dirty or worn              | Normal wear   | Clean and adjust or replace   |
|  | Carburetor                | Improper adjustment             | Vibration   | Adjust  |
|  | Cooling system            | Cooling system dirty or plugged | Extended operation in dirty or dusty locations                          | Clean   |
|  | Spark arrestor screen     | Spark arrestor screen plugged   | Normal wear   | Replace   |

| ENGINE PROBLEM TROUBLESHOOTING CHART |       |        |                         |                 |
|--------------------------------------|-------|--------|-------------------------|-----------------|
| Problem                              | Check | Status | Cause                   | Remedy          |
| Engine does not crank                | N/A   |        | Internal engine problem | See your dealer |

 **DANGER**

*Fuel vapors are extremely flammable and may cause fire and/or explosion. Never test for ignition spark by grounding spark plug near cylinder plug hole, otherwise serious personal injury may result.*

---

**STORAGE**

---

 **WARNING**

*The muffler and surrounding cover become hot during operation. Always keep exhaust area clear of flammable debris during transportation or when storing, otherwise serious property damage or personal injury may result.*

 **WARNING**

*Hedge Trimmer blades are very sharp. Touching them may lead to severe personal injury. Avoid touching blades whenever possible, and always wear gloves to protect hands.*

 **DANGER**

*Do not store in enclosure where fuel fumes may accumulate or reach an open flame or spark, otherwise serious personal injury may result.*

**NOTICE**

*Always store and transport hedge trimmers in a stable, horizontal position. Support gear case and cutting blades to prevent excessive flexing, which may cause damage to these components. Always install blade cover when transporting or storing unit.*

**Long Term Storage (Over 30 Days)**

Do not store your unit for a prolonged period of time (30 days or longer) without performing protective storage maintenance which includes the following:

1. Store unit in a dry, dust free place, out of the reach of children.
2. Place the stop switch in the "STOP" position.
3. Remove accumulation of grease, oil, dirt and debris from exterior of unit.
4. Perform all periodic lubrication and services that are required.
5. Apply clean oil to the entire length of the blade. Be certain the blade bolts are lubricated.
6. Install blade cover on blades.
7. Tighten all the screws and nuts.

8. Drain fuel tank completely. Press purge bulb 6-7 times to remove remaining fuel from carburetor then drain the tank again. Close choke, start and run the engine until it stops due to lack of fuel.
9. Allow engine to cool. Remove the spark plug lead from the spark plug. Remove the spark plug. Pour 7 cc (0.25 oz.) of fresh, clean, two-stroke engine oil into the cylinder through the spark plug hole.
  - a. Place a clean cloth over the spark plug hole.
  - b. Pull the recoil starter handle 2-3 times to distribute the oil inside the engine.
  - c. Observe the piston location through the spark plug hole. Pull the recoil handle slowly until the piston reaches the top of its travel and leave it there.
10. Install the spark plug. Connect the spark plug lead to the spark plug.

## SPECIFICATIONS

| MODEL              | HC-2210  | HC-2810           |
|--------------------|--|-------------------|
| Length             | 1,063 mm (41.9 in.)  | 1,193 mm (47 in.) |
| Width              | 272 mm (10.7 in.)  |                   |
| Height             | 195 mm (7.7 in.)   |                   |
| Weight (dry)       | 5 kg (11 lb.)  | 5.2 kg (11.4 lb.) |
| Engine Type        | Air cooled, two-stroke, single cylinder gasoline engine  |                   |
| Bore               | 32.2 mm (1.27 in.)   |                   |
| Stroke             | 26.0 mm (1.02 in.)   |                   |
| Displacement       | 21.2 cc (1.29 cu. in.)   |                   |
| Exhaust            | Spark arrestor muffler or spark arrestor muffler with catalyst   |                   |
| Carburetor         | Diaphragm w/purge pump   |                   |
| Ignition System    | Flywheel magneto, capacitor discharge ignition type  |                   |
| Spark Plug         | NGK BPMR-8Y (Gap 0.65 mm (0.026 in.))  |                   |
| Fuel               | Mixed (Gasoline and Two-stroke Oil)  |                   |
| Gasoline/Oil Ratio | 50 : 1   |                   |
| Gasoline           | Use 89 Octane unleaded. Do not use fuel containing methyl alcohol, more than 10% ethyl alcohol or 15% MTBE. Do not use alternative fuels such as E-15 or E-85. |                   |
| Oil                | ISO-L-EGD (ISO/CD 13738) and J.A.S.O. M345- <u>ED</u> , two-stroke, air-cooled engine oil.   |                   |

| <b>MODEL</b>                      | <b>HC-2210</b>                          | <b>HC-2810</b>    |
|-----------------------------------|---|-------------------|
| Fuel Tank Capacity                | 0.37 lit. (12.5 US fl. oz.)             |                   |
| Starter System                    | Automatic Recoil Starter                |                   |
| Clutch                            | Centrifugal Type                        |                   |
| Gear Case Ratio                   | 4.6:1                                   |                   |
| Cutter                            | Double Reciprocating Blade, Double Edge |                   |
| Length                            | 501mm (19.7 in.)                        | 624 mm (24.6 in.) |
| Pitch                             | 35mm (1.38 in.)                         |                   |
| Height                            | 24mm (0.94 in.)                         |                   |
| Maximum Diameter Cut:             |   |                   |
| Soft Material                     | 25.4mm (1 in.)                          |                   |
| Woody Material                    | 13mm (1/2 in.)                          |                   |
| Idle Speed                        | 3,300 RPM                               |                   |
| Clutch Engagement Speed           | 4,700 RPM                               |                   |
| Wide Open Throttle Speed (W.O.T.) | 10,740 RPM                              |                   |

**PRODUCT REGISTRATION**

**Thank you for choosing ECHO Power Equipment**

Please go to <http://www.echo-usa.com/Warranty/Register-Your-ECHO> to register your new product on-line. It's **FAST** and **EASY!** NOTE: your information will never be sold or misused by ECHO, Inc. Registering your purchase enables us to contact you in the unlikely event of a service update or product recall, and verifies your ownership for warranty consideration.

If you do not have access to the Internet, you can complete the form below and mail to:

**ECHO Inc., Product Registration, PO Box 1139, Lake Zurich IL 60047.**





PRODUCT REGISTRATION CARD : TARJETA DE REGISTRO : CARTE D'ENREGISTREMENT DU PRODUIT

**ONLINE OPTION:** Register online and save a stamp! You will be alerted of product updates and/or be sent new ECHO product information and special offers. Simply go to: [www.echo-usa.com](http://www.echo-usa.com)

**OPCIÓN POR INTERNET:** Regístrese en la página web y ahorre una estampilla! Le alertarán sobre actualizaciones del producto y/o se le enviará información sobre los nuevos productos ECHO y ofertas especiales. Simplemente visite: [www.echo-usa.com](http://www.echo-usa.com)

**OPTION EN LIGNE:** Enregistrer en ligne et épargner un timbre! Vous serez informé sur les nouveaux produits ECHO et les mises à jour de produit ainsi que les offres spéciales. Simplement visitez le: [www.echo-usa.com](http://www.echo-usa.com)

Please Print : Por Favor Enscriba Con Letra De Molde : En Lettre Carré S.V.P. **Confidential:** Information provided will not be shared or sold

|  |   |
|--|---|
| Purchaser's Name : Nombre del Comprador : Nom de l'acheteur              |   |
| Address : Dirección : Adresse  |   |
| City : Ciudad : Ville  | Zip Code - Código Postal : Code Postal                  |
| State : Estado : Province  |   |
| E-Mail Address : Dirección De Correo Electrónico : Courriel Electronique |   |
| Phone Number : Número De Teléfono : Téléphone                            | Date of Purchase : Fecha de la Compra : Date de l'achat |
| Where Purchased : Nombre del Almacén donde fue Comprado : Lieu d'achat   |   |
| Model Number : Numero del Modelo : No. de modèle                         | Serial Number : Numero de Serie : No. de série          |

Registering your purchase enables us to contact you in the unlikely event of a service update or product recall and verifies your purchase for warranty purposes. We will never give your name, address or phone number to anyone without your permission. Como el aviso de tiempo de servicio o la revocación del producto y verificación de propiedad en caso de robo o pérdida. L'enregistrement de votre achat nous permettra de vous contacter dans le cas improbable de modifications des instructions d'emballage ou de rappel du produit et vérifier que vous êtes le propriétaire en cas de vol ou de perte.

Primary use of tool:  Homeowner  Rental Equip.  
 Uso primario de la herramienta:  Profesional  Dueño de casa  Alquiler  
 Usage principal:  Professionnel  Residential  Location  
 Do you wish to receive periodic ECHO product information and special offers by e-mail?  Yes  No  
 ¿Desea usted recibir información periódica y ofertas especiales por correo electrónico sobre el producto ECHO?  Yes  No  
 Souhaitez-vous recevoir périodiquement de l'information sur les produits ECHO et les offres spéciales par courrier électronique?  Oui  Non  
 Did you visit the ECHO website before purchasing your product?  Yes  No  
 Visitéz-vous le site ECHO avant de acheter votre produit?  Si  Non  
 Avez-vous visité le site d'ECHO avant de procurer votre produit?  Oui  Non  
 What factor(s) most influenced your purchase?  
 Performance  Price  Dealer  
 Reliability  Prior Experience  Quality  
 Friend/Family  Brand  Warranty  
 ¿Que factor(es) influenció más en su compra?  
 Funcionamiento  Precio  Distribuidor  
 Confiabilidad  Experiencia Anterior  Calidad  
 Amigo/Familia  Marca  Garantía  
 Quel facteur (facteurs) vous a influencé le plus?  
 Performance  Prix  Marchand  
 Fiabilité  Expérience  Qualité  
 Ami/Famille  Marque  Garantie

ECHO INC., 400 Oakwood Rd., Lake Zurich, IL 60047  
 1.800.432.ECHO [WWW.ECHO-USA.COM](http://WWW.ECHO-USA.COM)

X7572270206 02-2012



NOTES

---



U28815001001 - U28815999999  
U28915001001 - U28915999999



**ECHO INCORPORATED**

400 Oakwood Road  
Lake Zurich, IL 60047  
[www.echo-usa.com](http://www.echo-usa.com)