

# HEDGE TRIMMER SAFETY MANUAL



**DANGER**



*Misuse may result in serious or fatal injuries. You must read, understand, and follow these safety instructions and the instructions in your Operator's Manual before operating a Hedge Trimmer.*



**DANGER**



*Hedge Trimmer blades are very sharp and can cause severe injuries, even if engine is off and blades are not moving. Avoid contact with blades. Wear gloves to protect hands. Place blade cover on blades when transporting or storing unit.*

# INTRODUCTION



## WARNING

ENGLISH

*This manual describes how to protect yourself and others from hazards related to operation of a gasoline or electric-powered hedge trimmer.*

*Before assembling, fueling, or operating your hedge trimmer, you must read this Safety Manual and your Hedge Trimmer Operator's Manual. You must also understand and obey all safety rules, precautions, and operating instructions.*

*You must also be alert at all times, and be physically capable of handling and controlling a power hedge trimmer in a variety of cutting applications. If you are unable to handle the hedge trimmer safely, or if you feel that the cutting task you wish to perform may put yourself, your property, or others at risk, please call a professional landscape maintenance company to handle the job.*

### Table of Contents

INTRODUCTION .....	2
SAFETY SYMBOLS AND WARNINGS .....	3
OPERATOR SAFETY .....	6
PHYSICAL CONDITION .....	7
PERSONAL PROTECTIVE EQUIPMENT .....	7
PROTECTIVE CLOTHING .....	8
PROTECTION AGAINST COLD OR VIBRATION .....	9
ASSEMBLY .....	11
BLADE COVER .....	11
BLADE STIFFENER INSTALLATION .....	12
FUELING .....	13
STARTING .....	16
STOPPING .....	17
OPERATION .....	18
CUTTING .....	18
FUEL LEAKS .....	20
MECHANICAL PROBLEMS .....	21
CUTTING - SHAFT HEDGE TRIMMERS .....	21
CLEARING JAMS .....	23
MAINTENANCE .....	24
STORAGE .....	25
ELECTRIC HEDGE TRIMMERS .....	26
SPECIAL PRECAUTIONS FOR ELECTRIC HEDGE TRIMMERS .....	26
ELECTRIC POWER OPERATING SAFETY .....	28
GLOSSARY .....	29

# SAFETY SYMBOLS AND WARNINGS

---

These important safety symbols and warnings are used throughout this manual, and may also appear in your Operator's, Attachment, or Installation Instruction Manual. These symbols and warnings are provided to help make you aware of potential hazards, and the precautions you must take to protect yourself from injury. You must read and understand this information, and obey the instructions. These symbols may also appear on safety labels as a visual reminder to follow these important precautions whenever you are transporting, fueling, operating, servicing, handling, or storing your unit.

---

## Circle/Slash Prohibition Symbol

This symbol means that the specific action shown is prohibited. Ignoring these prohibitions can result in serious or fatal injury.



## Safety Alert Symbol

The Safety Alert symbol is used to alert you to potential personal injury hazards. To avoid serious or fatal injuries, obey all safety messages that follow this symbol.



## Safety Alert Symbol/DANGER Signal Word

The safety alert symbol appearing with the word "Danger!" calls attention to a hazard which will result in death or serious injury if not avoided.



## Safety Alert Symbol/WARNING Signal Word

The safety alert symbol appearing with the word "Warning!" calls attention to a hazard which could result in death or serious injury if not avoided.



## Safety Alert Symbol/CAUTION Signal Word

The safety alert symbol appearing with the word "Caution!" calls attention to a hazard which could result in minor or moderate injury if not avoided.



## NOTICE signal word only. (No safety alert symbol)

The word "NOTICE" calls attention to a situation which may result in property or equipment damage if the information that is provided is not followed.

**NOTICE**

# SAFETY SYMBOLS AND WARNINGS

---

## Read Operator's and Safety Manuals

Read manuals carefully, and follow rules for safe operation. Failure to do so could result in serious or fatal injury.

---



## Wear Head, Eye, and Hearing Protection

Wear head, hearing, and eye protection that meet ANSI requirements.

---



## Wear Hand Protection

Wear heavy duty work gloves to protect hands

---



## Sharp Blades Alert

Contact with blades can result in serious cuts and amputation

---



## Carbon Monoxide Hazard Alert

Do not operate indoors. Breathing carbon monoxide can cause serious or fatal injuries.

---



## Explosion Hazard Alert

Gasoline vapor can explode if exposed to sparks or open flame.

---



## Burn Hazard Alert

Contact with hot surfaces can cause serious burns.

---



## Fire Hazard Alert

Risk of fire from gasoline spills or leaks. Wipe up spills immediately and dispose of wipes in an approved fire-safe container.

---



## Shock Hazard Alert

Unit not insulated against electrical current. Avoid power lines.



# SAFETY SYMBOLS AND WARNINGS

## Slip Hazard Alert

Wear slip-resistant footwear to reduce risk of falls.



## Finger Sever Hazard

Moving parts can amputate fingers or cause severe injuries. Keep hands, clothing and loose objects away from all openings.



## Prohibited Clothing

Wear protective clothing and shoes. Loose clothing, dangling accessories, or open footwear increases risk of serious injury.



## Stop Symbol

Indicates the "Stop" position for the engine ignition switch (Stop Switch).



## Keep Bystanders 15m (50 feet) Feet Away

Keep bystanders at least 15m (50 feet) away when operating unit.



## Do Not Operate Near Electrical Lines

Do not operate closer than 15m (50 feet) to electrical lines.

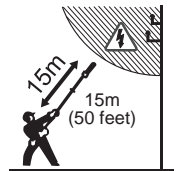

## Flame Prohibition

Do not allow flames or sparks near fuel or fuel vapors.



## No Smoking Prohibition

Do not smoke near fuel.



# SAFETY SYMBOLS AND WARNINGS

## Do Not Operate Equipment While Impaired

Do not operate equipment while under the influence of alcohol, medication, or any other substance that can impair judgment, reflexes, vision, or coordination. Operating a unit while impaired can result in serious injury to operator and bystanders, or cause damage to property or equipment.



## Operate Only With Handle Guard/Do Not Remove Hand Guard (Double-sided Blades)

Do not operate without hand guard in place.



## Operate Only With Handle Guard/Do Not Remove Hand Guard (Single-sided Blades)

Do not operate without hand guard in place.

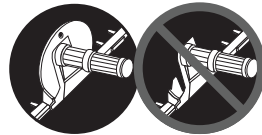

## OPERATOR SAFETY



# DANGER

*Hedge trimmers are powerful, professional-grade tools designed to cut through bushes, hedges, shrubs, and other woody growth. When used properly, these hedge trimmers save time, reduce effort, and make difficult landscaping tasks easy. If handled carelessly or used improperly, these powerful cutting tools can cause severe injury or death.*

**Before using these hedge trimmers, you must:**

- Read and understand this Safety Manual
- Read and understand the Operator's Manual provided with your unit.
- Wear appropriate protective equipment
- Make sure all others who use the hedge trimmers have read and understand both manuals before fueling or operating the tool.
- Clear the work area of bystanders and pets
- Clear the work area of debris and other work hazards
- Make sure you have safe, unobstructed footing
- Make sure the material to be cut is free of hidden hazards
- Safely prepare the fuel/oil mix
- Fuel your unit safely
- Store the fuel container safely

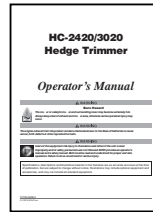

## PHYSICAL CONDITION

### WARNING

*Operating this unit while you are impaired can result in serious personal injury or death to yourself and others. Never operate the unit if you are fatigued, or are under the influence of alcohol, medication, or any other substances that can affect your judgment, reflexes, vision, or coordination. You must be mentally alert and physically able to operate a hedge trimmer safely. If you are impaired in any way, or are physically unable to safely operate and control the unit, do not fuel, start, or attempt to use the unit*



## PERSONAL PROTECTIVE EQUIPMENT

### WARNING

*Operating a power hedge trimmer exposes you to sharp, fast-moving blades, powerful cutting action, flying debris, sharp sticks and branches, and other work area hazards. These hazards can cause serious injury to you and others if you do not take the precautions necessary to protect yourself.*

*To help protect against injury caused by these hazards, you must wear appropriate personal protective equipment:*



### Eye and Face Protection

Wear eye protection that meets ANSI Z87.1 requirements. For additional safety, a full-face shield may be worn over safety goggles to provide protection from sharp branches or flying debris.

# OPERATOR SAFETY

ENGLISH

## Hearing/Ear Protection

ECHO Inc. highly recommends wearing ANSI-approved hearing protection whenever you are operating the unit. Hearing protection prevents hearing loss caused by frequent or prolonged exposure to engine noise. ECHO Inc. recommends ear plugs, or for constant, heavy-duty use, wear earmuff-style hearing protection.



## Combination Head/Eye/Face/Hearing Protection

For complete eye/face/hearing protection, the use of a combination safety helmet/ear muffs/face shield provides head, face, and hearing protection all in one unit.

**ALWAYS** wear safety glasses or goggles under the face shield, and wear head protection when cutting overhead using a PAS or SB unit with Power Pruner or Hedge Clipper Attachments



## PROTECTIVE CLOTHING

### Gloves

Wear sturdy work gloves to provide protection against cuts and scratches.



## WARNING

**Sharp Blades/Powerful Cutting Action.** Work gloves and other heavy work clothing may not provide protection against serious injury if contact is made with moving blades. Contact with cutting edges of moving blades will cause severe injury or amputation. Keep hands, fingers, and all other body parts away from moving blades.

**Always move ignition switch to STOP position, allow blades to stop moving, and disconnect spark plug lead from spark plug before clearing jams or making blade adjustments.**



### Leg Protection

Wear long pants to protect legs from cuts and scratches caused by sharp branches.

### Foot Protection

Wear sturdy shoes or work boots to provide foot protection. Steel-toe shoes or boots provide extra protection against dropped or falling objects. Make sure soles are non-slip for secure footing.

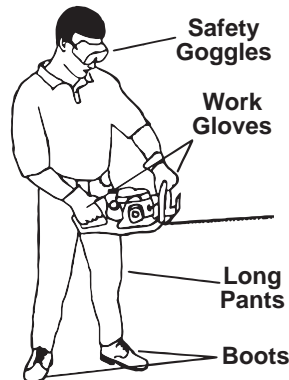

**Always wear proper clothing when using the hedge trimmer.**



## General Clothing Safety

Never wear ties, loose clothing, or clothing with strings, frills, or dangling straps. Keep clothing buttoned or zipped, and keep shirt tails tucked in. Never wear dangling or hanging jewelry such as earrings or necklaces, or any other items that could become entangled with branches or equipment, and be drawn into the air intake grid of the engine.

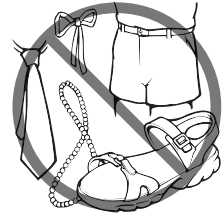

## Dust Protection

Operators who are sensitive to wood dust or other common airborne allergens may need to wear a dust mask to prevent inhaling these materials while cutting. Dust masks can provide protection against sawdust, plant debris, and other plant matter such as pollen. Make sure the mask does not impair your vision, and replace the mask as needed to prevent air restrictions.



## PROTECTION AGAINST COLD OR VIBRATION

### CAUTION

*Prolonged exposure to cold and/or vibration may result in injury. Read and follow all safety and operation instructions to minimize risk of injury. Failure to follow instructions may result in painful wrist/hand/arm injuries.*



*Wear sturdy work gloves to help reduce the effects of cold and vibration, and to help improve your grip.*

## Raynaud's Syndrome

A condition known as Raynaud's Syndrome can occur from exposure to cold and/or vibration. This condition affects the hands and arms, causing tingling, burning, numbness, and loss of color in the fingers. The amount of exposure needed to trigger this is unknown, and varies by individual.



To protect yourself from this condition, take the following precautions:

- Keep your body warm - pay particular attention to head and neck, hands and wrists, and feet and ankles.
- Avoid awkward grips on the unit that may cause stress. Maintain control, but do not hold the unit with an excessively tight grip.
- Take regular rest breaks.
- Exercise and stretch to strengthen muscles, and to maintain circulation. Keep exposure to vibration at a minimum.

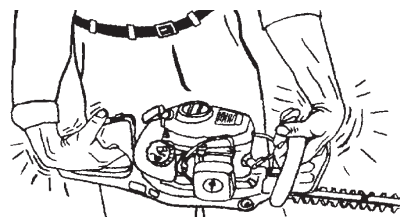

# OPERATOR SAFETY

---

- If you experience discomfort, redness, and/or swelling of the fingers, followed by whitening or loss of feeling, stop using the unit, and contact a doctor.

## Repetitive Stress Injuries (RSI)

Overuse of the muscles and tendons of the fingers hands, arms, and shoulders may cause soreness, swelling, numbness, weakness, and pain in these areas. Repetitive hand/wrist movement can put you at high risk for developing a Repetitive Stress Injury (RSI), such as Carpel Tunnel Syndrome (CTS). Carpal Tunnel Syndrome occurs when swelling in the wrist puts pressure on a nerve, resulting in severe pain.

**To protect yourself from these conditions, take the following precautions:**

- Avoid using your wrist in a bent or twisted position. Try to maintain a straight wrist position.
- Avoid using your thumb and index finger to grip things - use your whole hand.
- Take regular rest breaks.

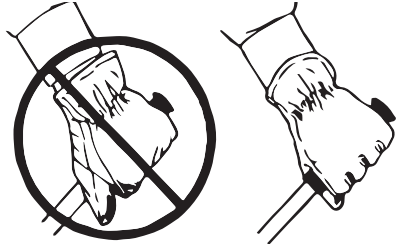

- Exercise and stretch to strengthen muscles and maintain circulation.
- Keep exposure to vibration at a minimum.
- Reduce the speed and force of repetitive movements.
- If you experience tingling, numbness, or pain in the fingers, hands, wrists, or arms, stop using the unit immediately, and contact a doctor. Early diagnosis of RSI can help prevent permanent nerve and muscle damage.

 **WARNING**

***Hedge trimmer blades are extremely sharp. Accidental hand or body contact with blades can result in severe cuts, even if the engine is off and blades are not moving. Always wear sturdy work gloves when handling the hedge trimmer, and do not allow blades to touch any part of your body.***



If your hedge trimmer requires assembly before it can be used, you must make sure all guards, shields, and protective devices are properly installed. NEVER fuel, start, or operate your unit without all guards and shields in place, or without all protective devices such as throttle lock-out levers working properly.

If parts are missing, or if you have a problem installing parts, contact your Dealer for assistance or call Consumer Product Support.

After assembly, check your unit to make sure guards, shields, protective devices, and all other parts are properly and securely assembled and working correctly. See the Operator's Manual for details about part locations for your unit.

- Make sure all required hardware has been used and is properly tightened.
- Make sure throttle lock-out lever resets when released.
- Make sure throttle trigger returns to normal position when released.
- Make sure stop switch functions properly

## **BLADE COVER**

The hedge trimmer blades are covered by a removable protective cover to prevent accidental contact with sharp edges. Keep the protective cover on the blades until you are ready to install the blade stiffener, make blade adjustments, or operate the hedge trimmer. Place the blade cover over the blades after cutting is completed, and keep the blade cover on the blades when carrying, transporting, or storing the unit.



## BLADE STIFFENER INSTALLATION



### WARNING

*A blade stiffener is provided with most hedge trimmer models. The blade stiffener is strongly recommended for use in all homeowner or light duty cutting applications. In commercial cutting applications, or when cutting thick, dense branches, cutting capacity may be increased by cutting without the blade stiffener.*

Use extreme care when cutting without blade stiffener. Follow instructions in Operator's Manual to install or remove blade stiffener.



### WARNING

*Accidental contact with blades can cause serious injury. Avoid ALL bodily contact with cutting edges. Stabilize unit before working on blades. Use properly sized metric socket wrenches and minimum 4 inch (100 mm) long socket wrench extension to keep hands at a safe distance from blades when installing and removing blade stiffener, or whenever adjusting blade tightness.*

### IMPORTANT

New locknuts must be used every time blade stiffener is installed, and blade bolt adjustment instructions must be followed EXACTLY. Failure to follow instructions, or to use new locknuts, may damage blades or gearbox and result in rapid blade wear and poor cutting performance.



## DANGER

**Explosion/Fire/Burn Hazard. Gasoline is extremely flammable. Vapors are explosive. Keep at least 50 feet (15 m) away from heat, sparks, open flame, smoking materials, static electricity, and all other sources of ignition when fueling unit.**

**Gasoline vapor is heavier than air, and can travel along the ground to nearby sources of ignition such as electrical motors, pilot lights, and hot or running engines. Vapors ignited by an ignition source can flash back to the fuel container, resulting in an explosion, fire, serious or fatal injuries, and extensive property damage.**

Follow these important safety precautions to minimize risk of explosion or fire:

- **ALWAYS** use an approved fuel container with tight-fitting caps.
- **ALWAYS** follow posted safety instructions for filling fuel containers at filling stations.
- **ALWAYS** place container to be filled with gasoline on the ground to prevent static buildup during filling.
- **ALWAYS** keep the metal filling pump nozzle in contact with the fuel container while dispensing fuel to prevent buildup and discharge of static electricity.
- **NEVER** fill fuel container on SUV/truck bed or in trunk of car.
- **NEVER** smoke near fuel.
- **NEVER** allow flames or sparks near fuel.
- **ALWAYS** loosen fuel caps slowly to allow pressure in tanks and containers to escape
- **ALWAYS** use extreme care when mixing, storing, or handling fuel.
- **NEVER** remove tank cap or refuel a unit while the engine is hot or running
- **NEVER** fill fuel tanks indoors - ALWAYS fill fuel tanks outdoors over open ground.
- **DO NOT** overfill fuel tank - ALWAYS allow room in tank for expansion. Fill tank no more than 95 percent full, or to "Safe Fill Line" if marked on container.

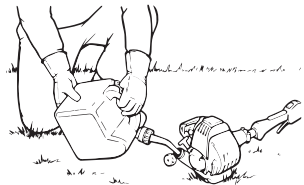

**Fill Fuel Outdoors**

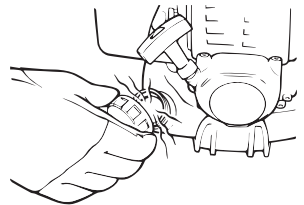

**Open Fuel Cap Slowly**

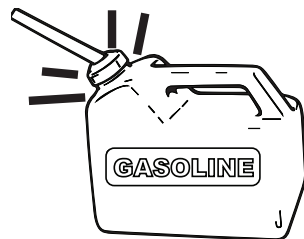

**Tighten cap securely**

# FUELING

ENGLISH

- **ALWAYS** wipe up spills immediately, and dispose of fuel soaked wipes safely. Use a fireproof container designed for safe disposal.
- **IMMEDIATELY** change clothes if fuel spills on clothing. Wet clothes down with water first to minimize fire risk.
- **ALWAYS** tighten fuel tank cap securely - check cap for tightness.
- **ALWAYS** close fuel container immediately after refueling.
- **ALWAYS** check fuel system for leaks before using unit - NEVER start or operate a unit with leaks.
- **ALWAYS** move at least 3 m (10 ft.) away from refueling location before starting engine.
- **STOP USING UNIT IMMEDIATELY** and shut engine ignition off if you smell the strong odor of gasoline. Set unit down in a safe location, and allow to cool before checking for leaks.
- **ALWAYS** store fuel containers in a well ventilated, unoccupied building, away from heat, sparks, open flames, and other sources of ignition.

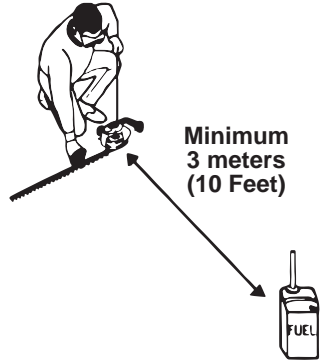

## Fuel Mix



## WARNING

**2-Stroke engine oil contains petroleum distillates and other additives that may be harmful if swallowed. Heated oil can release vapors that can cause flash fire, or ignite with explosive force. Read and follow the oil manufacturer's instructions, and observe all safety warnings and precautions for handling flammable liquids.**

- **KEEP OUT OF REACH OF CHILDREN.**
- If swallowed, do not induce vomiting. **CALL PHYSICIAN OR A POISON CONTROL CENTER IMMEDIATELY.**
- **AVOID** prolonged contact with skin.
- **WEAR SAFETY GLASSES** when mixing or handling.
- **AVOID** repeated or prolonged skin contact.
- **AVOID** inhaling oil mists or vapors.
- **ALWAYS** wipe up spills promptly - spills may create a slip hazard if not attended to
- **NEVER** store oil in open or unmarked containers.



2-Stroke Engine Oil

Also, follow these important safe-handling precautions to minimize risk of explosion or fire when preparing fuel/oil mix:

- **ALWAYS** prepare fuel/oil mix in an approved fuel container
- **ALWAYS** follow mixing instructions in Operator's Manuals.
- **ALWAYS** make sure fuel container caps are tightly secured before shaking container to mix fuel and oil.
- **ALWAYS** store fuel containers in a safe location, with caps and vents sealed tightly.

For more detailed safety and first aid information, visit the oil manufacturer's website for a copy of the Material Safety Data Sheet, or contact the oil company.

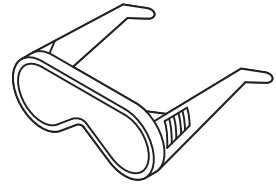

**Wear Safety Glasses when mixing or handling fuel**

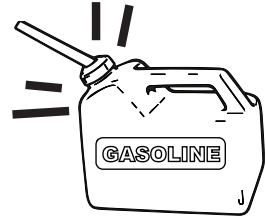

**Tighten cap before shaking container**



## DANGER

***Alternative fuels, such as E-20 (20% ethanol), E-85 (85% ethanol) or any fuels not meeting requirements are NOT approved for use in 2-stroke gasoline engines. Use of alternative fuels may cause performance problems, loss of power, overheating, fuel vapor lock, and unintended machine operation, including, but not limited to, improper clutch engagement. Alternative fuels may also cause premature deterioration of fuel lines, gas-kets, carburetors and other engine components.***

**NEVER** use raw (unmixed) fuel, or any high-ethanol fuel (ethanol content greater than 10%) such as E20 -E85, in a two-stroke engine.

Fuel containers filled with 2-stroke engine fuel/oil mix should be identified as containing fuel/oil mix, and should be stored separately to prevent using raw or high ethanol gasoline in a two-stroke engine.



# STARTING

ENGLISH

## DANGER

*The blades on units that require starting at wide-open throttle (throttle trigger fully depressed) will start moving immediately when the engine starts. To avoid loss of control and serious injury, stay clear of blades, and keep blades away from objects that could become entangled. Release throttle trigger immediately when engine starts*

*The Operator's Manual for your unit provides specific starting instructions for your model and type of engine. For your safety, follow these starting instructions, and observe the safety rules provided. Before starting the unit, make sure you know the location of the unit's "STOP" switch, and know how to perform an emergency stop in case of a switch malfunction. (See "Stopping" on next page.)*

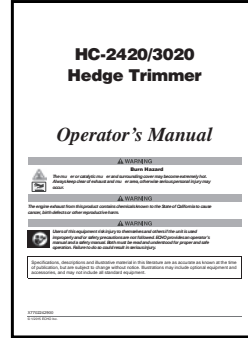

The Hedge Trimmer blades must not move at idle, otherwise serious personal injury may result. Periodic carburetor adjustment may be necessary to assure blades do not move at idle. If blades move during idle, **shut unit off immediately**, and readjust carburetor according to "Carburetor Adjustment" instructions and idle speed specifications provided in your Operator's Manual. See your dealer or contact Consumer Support for help if you have any questions.

Follow these important safety rules when starting your unit:

- **NEVER** start or run your unit indoors or anywhere where there is poor air circulation. Indoor operation produces dangerous levels of Carbon Monoxide, a colorless and odorless poisonous gas. Carbon Monoxide (CO) causes nausea and other flu-like symptoms if breathed. Prolonged exposure to CO may cause loss of consciousness, brain damage, or death.
- **NEVER** start a hedge trimmer near a gasoline container or spilled gasoline.
- **ALWAYS** move at least 3 m (10 ft.) away from refueling location before starting engine.
- **ALWAYS** remove blade cover before starting unit. Keep blade cover nearby, and place cover back on blades when unit is off and blades have stopped.
- **NEVER** start an HCA (extended shaft, articulating blade) unit while blade is in folded/locked position. Make cutting angle adjustment first.
- **ALWAYS** start the hedge trimmer flat on the ground, with blades clear of all obstructions

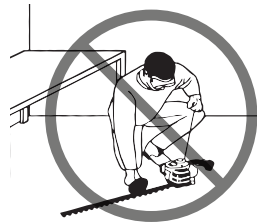



# STARTING

- **NEVER** “drop start” the unit or attempt to start the unit while it is resting on blade tips.
- **ALWAYS** grip the unit firmly when starting to prevent loss of control when pulling starter handle.
- **ALWAYS** hold the unit securely with both hands after it starts, using the front and rear handles.
- **MAINTAIN** a secure, two-handed grip at all times while unit is in use.
- **ALWAYS** shut unit off immediately if it shakes or vibrates excessively when started. Tag unit, and have it checked by an authorized service center before placing back in use.



# STOPPING

The “STOP” switch stops the unit by grounding the ignition and preventing the spark plug from discharging a spark. If the STOP switch malfunctions and does not stop the unit when required, use the choke to stall the engine to a stop, and have your dealer repair the switch before using the unit again.



Use this “Emergency Stopping sequence only if the STOP switch malfunctions:

- Release trigger and allow engine to return to idle and blades to stop.
- After the engine has returned to idle and blades have stopped, place the unit on a safe, flat surface, clear of blade obstructions.
- Keep one hand on the throttle control handle assembly to maintain control of the unit, and move the choke control lever to the closed, “COLD START” (choke symbol) position to stall the engine.
- Hold the unit with a secure, two-handed grip, and wait for the engine to stall to a complete stop.
- After the engine stops and blades have stopped moving, disconnect the spark plug lead, and tag the unit to identify it as having a broken STOP switch.
- Do not restart the unit. Have the unit repaired before using it again.

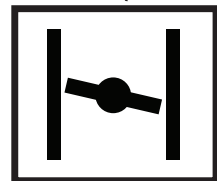
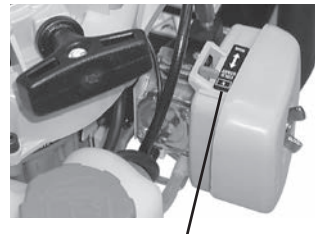
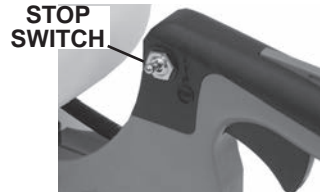

**CHOKE CLOSED  
(COLD START POSITION)**

# OPERATION

## DANGER

*Hedge trimmer blades are extremely sharp. Moving blades have powerful cutting action. Contact with moving blades will cause serious injury. Keep hands, feet, and all other body parts away from blades at all times. Wear work gloves, safety glasses, hearing protection, and protective clothing.*

*Engine exhaust contains carbon monoxide, a poisonous gas. Breathing carbon monoxide can cause loss of consciousness, serious injury, or death. Start and operate outdoors only.*

*All equipment features spark-arresting mufflers as standard equipment. Spark arrestors prevent hot, glowing particles of carbon from being discharged from the muffler. Operation without a damaged, loose, or missing spark arrestor can result in fire.*

*The exhaust produced by Gasoline-powered equipment is hot, and can cause burns or ignite nearby flammable materials. Never blow engine exhaust against your body or toward flammable materials. The muffler and surrounding area become extremely hot during use, and can cause serious burns if touched.*

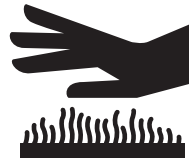

## CUTTING

To cut, hold the hedge trimmer firmly with two hands, with thumbs wrapped around the handles for a secure grip. Squeeze the throttle trigger slowly to accelerate the engine, and carefully feed the blades into the material to be cut.

Obey these important precautions when cutting:

- **ALWAYS** use two hands to operate your hedge trimmer. DO NOT operate the unit one-handed. If the hedge trimmer slips out of your hands, DO NOT attempt to catch the unit -- let the unit fall to the ground. If you grasp the cutting blades, serious personal injury may occur. Reduce the possibility of slipping by using a firm grip with thumbs and fingers encircling each handle.
- **ALWAYS** cut using a stable stance with both feet on the ground. Be alert for hazards such as slippery surfaces, stairs, and landscaping features such as rocks, edging, and other items that can affect stable footing.
- **ALWAYS** wear appropriate personal protective equipment to provide protection to face, eyes, hearing, and hands. Wear protective clothing to minimize risk of cuts, scrapes, and burns.

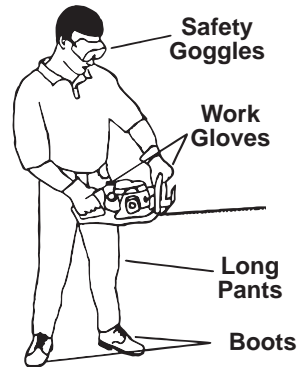

**Always wear proper clothing when using the hedge trimmer.**

- **NEVER** stand on a ladder or other temporary platform. You can fall or slip, and injure yourself or others. Use a shaft-mounted hedge trimmer to reach tall bushes and shrubs.
- **NEVER** hold or allow others to hold the material you are cutting.
- **ALWAYS** keep both hands on the unit to control the cutting action.
- **ALWAYS** keep the muffler exhaust directed away from your body.
- **NEVER** touch the muffler, muffler cover, or surrounding area during operation. Allow the unit to cool down before performing any maintenance in the muffler area.
- **NEVER** allow flammable debris such as dried leaves and sticks to build up in the exhaust area. Heat from operation can ignite these materials, and cause fire.
- **ALWAYS** keep fingers, hands, and all other body parts away from the cutting blades and cutting area.
- **NEVER** allow anyone to reach into the cutting area for any reason while the unit is running.
- **ALWAYS** maintain a direct line of sight to the hedge trimmer blades and the area where cutting is being performed. Be aware of what lies in the path of the blades at all times.
- **ALWAYS** maintain a minimum safety zone of 15 feet (5 meters) from where you are working. Don't allow others to enter the safety zone unless you have shut the hedge trimmers off and the blades have completely stopped moving.
- **NEVER** feed blades toward your body when cutting - keep blades directed away from yourself at all times.
- **NEVER** exceed the cutting capacity of the hedge trimmers - forcing the blades to cut materials thicker than the hedge trimmer is designed to handle will result in jams, blade damage, and poor overall performance.
- **ALWAYS** use a suitable tool such as a pruner or chain saw to cut branches larger than the hedge trimmer's capacity.
- **NEVER** attempt to cut more than 6 inches of length from a hedge or shrub in one cutting pass. Use multiple passes for cleaner, safer cuts, and better control over blade position.

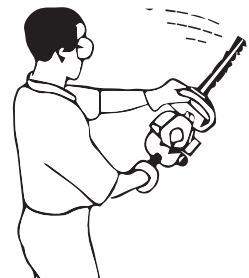
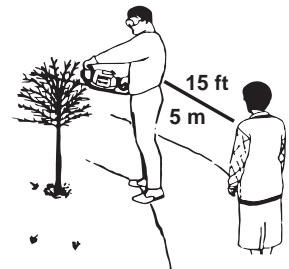

## OPERATION

- **NEVER** cut in the dark or when visibility of the cutting area is poor. You must be able to see the blades and cutting area at all times
- **ALWAYS** be alert for changes in hedge trimmer operation that could signal a problem - sudden vibration, unusual noise, strong smell of fuel, or poor cutting performance all require your immediate attention. **Stop the unit IMMEDIATELY if any of these problems occur, and correct the problems before continuing.**



## DANGER

**FUEL LEAKS POSE A RISK OF FIRE AND SERIOUS INJURY.**  
*The strong smell of fuel may be an indication of a loose fuel tank cap, a fuel system leak, or a fuel spill. STOP THE UNIT IMMEDIATELY, AND CHECK THE FUEL TANK CAP, FUEL TANK, FUEL LINES, AND CARBURETOR AREA FOR LEAKS.*

*If the unit is hot, place the unit on the ground in a safe area away from sparks, open flame and other sources of ignition, and allow the unit to cool down before handling or draining fuel.*

*If fuel has leaked onto clothing, avoid contact with heat, sparks, open flame, smoking materials, static electricity, and other sources of ignition. Wearing fuel-soaked clothing can result in serious or fatal injuries from burns. Pour water on clothing immediately, and change into dry clothing as soon as possible.*

## FUEL LEAKS

After the unit has cooled, pour fuel remaining in the tank into an approved fuel container. Purge any fuel left in purge bulb by pressing bulb until it is empty. Pour fuel removed from purge bulb into an approved fuel container, and tighten fuel container cap securely.

Tag unit to prevent refueling until leak has been corrected. Contact your dealer for service.

- **NEVER** transport a unit with a fuel leak until all fuel has been safely drained into an approved fuel container.
- **NEVER** continue to wear clothing that has had any fuel splashed, spilled, or leaked on it - wet clothing down with water immediately. Wash affected area, and change into dry clothing as soon as possible.
- **ALWAYS** dispose of fuel-soaked rags in a fire-proof safety container. Air-dry fuel-contaminated clothing outside, and wash with detergent and water before rewearing.
- **NEVER** put fuel-contaminated clothing into a clothes dryer to dry without first washing thoroughly.

If a fuel leak occurs while a unit is being transported in an enclosed truck or equipment trailer, or while unit is being stored between uses, safely vent spill area to dissipate fuel vapor. Do not allow heat, sparks, open flame, smoking materials, or other sources of ignition near spill area. Follow instructions for draining fuel from tool. Contact your dealer for service after tagging unit to prevent refueling until repairs have been made.

## MECHANICAL PROBLEMS

Sudden vibration, unusual noise, or poor cutting performance may all be indications of a loose or broken part, improper blade adjustment, or lack of lubrication. Operating the unit with any of these problems can cause a jam or other sudden malfunction that could result in an injury. Stop using the unit, and check it carefully for problems. Correct all problems before using unit again, or tag it until it can be repaired by an authorized servicing dealer.

## CUTTING - SHAFT HEDGE TRIMMERS

There are two basic types of extended reach, shaft-mounted hedge trimmers to meet the needs of professional landscapers and demanding homeowners. Shaft-mounted hedge trimmers (SHC models) provide the additional reach needed for trimming tall bushes and ornamental shrubs. Articulating hedge trimmers (HCA model ) provide extended reach, and also allow users to adjust the cutting angle of the blades.

Using shaft-mounted hedge trimmers requires that you follow additional safety rules to assure safe operation:

- **NEVER** operate unit within 50 Feet (15 meters) of overhead wires. Hedge trimmer shafts are not insulated against electrical current, and contact with wires could result in serious injury or death from electrical shock.
- **ALWAYS** wear head, face, and eye protection when cutting overhead to protect yourself from falling debris and sharp branches.
- **ALWAYS** check area to be cut for hazards before beginning. Cutting with an extended reach hedge trimmer may require trimming in an area that is not in the direct line of sight.
- **ALWAYS** use adjustment handle when adjusting blade angle, and lock blades securely before releasing handle.
- **NEVER** grip blades or use gear case to adjust blade position. Blade edges can cut through gloves, and gear case gets hot during use.
- **ALWAYS** wear gloves to protect hands against hot surfaces and accidental contact with sharp edges.

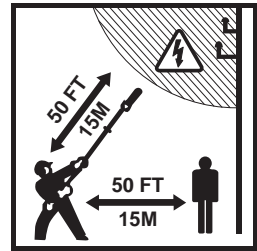

# OPERATION

ENGLISH

- **ALWAYS** operate unit with power head held to the right side of your body. Holding the unit on the left side of your body will allow hot exhaust gases to blow against you and your clothing.
- **NEVER** stand on a ladder or use any other unstable work surface while cutting. Handling a shaft hedge trimmer with extended reach requires secure footing and stable balance.
- **ALWAYS** stop engine before making adjustments. Make adjustments with unit positioned safely on the ground, or other flat surface that is free of debris or other obstructions.
- **NEVER** attempt to adjust cutting angle of HCA units with unit standing upright - ALWAYS adjust cutting angle with unit on the ground.
- **ALWAYS** make sure blades on HCA units are securely locked in position before lifting unit off ground. Improperly locked blades can pivot freely and strike you, causing serious injury.
- **ALWAYS** put plastic blade cover back on, and return HCA blades to folded and locked position when cutting has been completed.



## CLEARING JAMS

Hedge trimmers convert the rotary motion of the engine crankshaft into back-and-forth cutting motion to drive one or two hedge trimmer blades. This back-and-forth, reciprocating motion is produced by the gear case, which is driven by a clutch attached to the engine's crankshaft.

If the blades get jammed by a wire or other obstruction and can't move, the clutch allows the engine to keep running. As soon as the obstruction is removed, the blades are free to start moving again, instantly cutting whatever is left in the path of the blade teeth.

To protect yourself from serious injury when clearing jams, follow these important safety rules:

- **NEVER** reach for, or try to remove, jammed material while the engine is running.
- **ALWAYS** switch the unit off and disconnect the spark plug before clearing a jam. On electric powered units, switch the unit OFF, and unplug the power cord from the power outlet.
- **ALWAYS** inspect the blades after clearing a jam to make sure all jammed material has been cleared, and to make sure blades are not damaged.

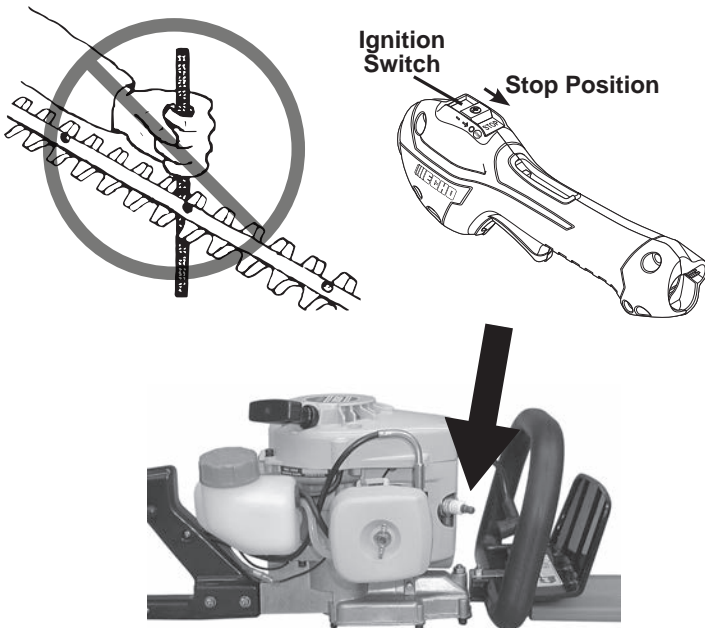



## WARNING

**Operating a poorly maintained hedge trimmer can result in serious injuries to operator and others. Maintain unit as instructed in Operator's Manual. Keep blades sharp and properly adjusted, and replace broken parts immediately.**

Your hedge trimmer requires regular maintenance for safe operation and reliable performance. Using a poorly-maintained unit can result in an injury caused by a part failure or other malfunction. Follow these important safety instructions to reduce the risk of injury caused by poor maintenance.

- **NEVER** test for ignition spark by grounding spark plug near cylinder plug hole. A spark could ignite fuel vapor, causing serious injury from explosion or fire.
- **NEVER** use a unit with broken, damaged, missing, or worn parts. Contact your dealer for repairs if problems are found.
- **NEVER** use substitute parts, parts from other models or brands, or used parts, when performing maintenance or repairs. Use only new parts that are manufactured for your specific serial number and model of hedge trimmer.
- **NEVER** make temporary repairs on a unit - taking shortcuts or using questionable parts and performing repairs that are not approved may create a safety hazard that can cause serious injury. Improper repair may also cause premature part failures, and void your product warranty.
- **ALWAYS** keep hedge trimmer blades sharp. Cutting with dull blades increases the chances of jams, reduces cutting efficiency, and increases operator fatigue.
- **ALWAYS** keep hedge trimmer blades properly adjusted. Improperly adjusted blades may result in poor cutting performance, increased risk of jams, and premature blade wear or failure.
- **ALWAYS** keep blades and gear case properly lubricated. Poor lubrication can cause result in part failures and cause overheating.
- **ALWAYS** keep fasteners tightened securely. Operation with loose fasteners can result in hazardous operation.

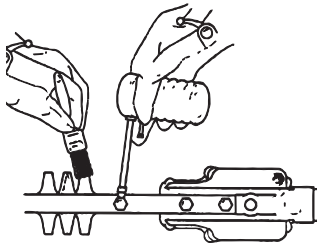
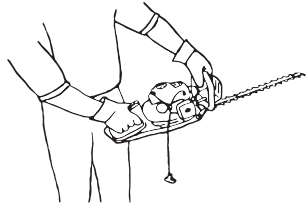
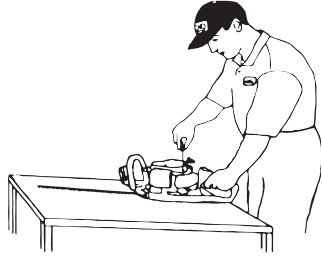



- **ALWAYS** perform a safety check after performing any service or maintenance on the unit. Make sure all parts have been properly installed, all hardware is properly tightened, and all guards and shields are in place.
- **ALWAYS** stop unit immediately and correct any problem if unit does not run properly after performing service or maintenance. Operating a unit that has been improperly repaired may result in serious injury.
- **ALWAYS** have major service performed by a qualified service technician. See your dealer for authorized service support.

## STORAGE

### DANGER

*Improper storage can result in fire, explosion, damage to equipment and property, and serious injury. Follow storage instructions in Operator's Manual. Obey all rules for safe fuel handling. Your Operator's Manual contains detailed instructions for preparing your unit for storage. Follow the instructions in your manual carefully, and make sure you observe these important safety precautions:*

- **NEVER** store a unit with fuel mix in the fuel tank. Leakage can result in fire.
- **ALWAYS** keep muffler exhaust area clear of flammable debris when storing or transporting unit. Allow unit to cool down before placing in a confined area such as a trunk, covered pickup truck bed, or enclosed trailer.
- **NEVER** store unit in an enclosure where fuel fumes can accumulate or reach an open flame or spark.
- **ALWAYS** stay away from heat, sparks, and open flame when draining fuel tank for prolonged storage. Wipe up spills immediately, and dispose of wipes and drained fuel safely.
- **ALWAYS** disconnect spark plug lead and install blade cover when storing unit, and keep unit out of the reach of children.

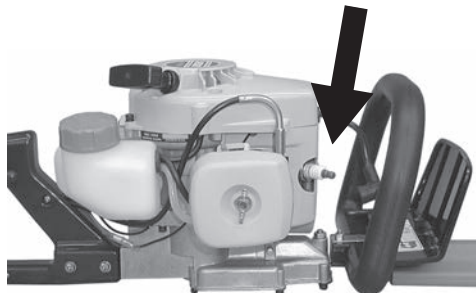

# ELECTRIC HEDGE TRIMMERS

ENGLISH

## SPECIAL PRECAUTIONS FOR ELECTRIC HEDGE TRIMMERS



**Shock/Electrocution Hazard. Read, understand, and obey all safety and operating instructions. Failure to follow all instructions can result in serious injury or death from electric shock.**

**Electric Hedge Trimmers expose users to risk of electric shock and electrocution, from contact with live electrical wires. Specific handling and safety precautions are required for safe operation, and must be followed. Make sure you observe all of these important safety rules:**

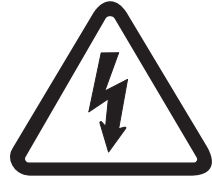

### Power Cord Safety

ALWAYS use a properly wired, UL-approved ground-fault circuit interrupter (GFCI) to minimize the risk of electric shock. GFCI devices are required for outdoor and "wet location" power outlets by most municipalities. Use a properly rated portable GFCI device if the available wall or outdoor outlet does not have ground fault protection wired in.

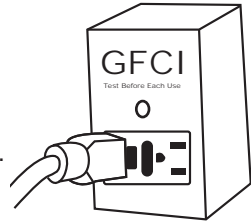

- **NEVER** use damaged or indoor use extension cords. Use only UL-approved 3-prong grounded cords approved for outdoor use.
- **ALWAYS** use an extension cord rated for the current required to power the hedge trimmer. Keep cord length to a minimum to prevent voltage drop, loss of power, and overheating of motor.
- **ALWAYS** provide a secure connection between hedge trimmer power cord and the extension cord being used to provide power. Tie a safety knot in the power cords to prevent accidental disconnection of the power cord during use.
- **ALWAYS** keep power cords away from hedge trimmer blades. Move away from the cord when cutting. Stop the unit and set it down if the power cord becomes tangled. Unplug the unit and reposition the cord before proceeding with cutting.



Recommended Minimum AWG Size for Extension Cords	
Total Cord Length	Correct Cord Gauge
25 feet	18 AWG
50 feet	16 AWG
100 feet	16 AWG
150 feet	14 AWG

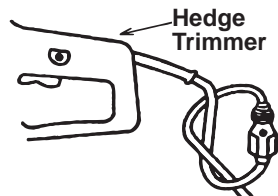

# ELECTRIC HEDGE TRIMMERS

- **NEVER** place the power cord on or in the material being cut. Use a longer cord to increase cutting reach if necessary, or use a power outlet nearer to the work area.
- **NEVER** carry the hedge trimmer by the power cord, or yank on the cord to disconnect it from a power outlet. Plug and unplug the cords using the connector plugs and sockets only.
- **ALWAYS** avoid sharp edges and abrasive surfaces that can damage power cord insulation. Damaged cords can cause electrical shock or electrocution, and sparks from short circuits can start fires.
- **ALWAYS** be aware of cord location, and the trip hazard that exists when extension cords are run along the ground. Use an extension cord with a bright color for ease of viewing, and make sure others are warned when cord is being moved to a new location.
- **NEVER** tie a power cord around your waist. Keep power cords free of all objects that could prevent the hedge trimmer from being held properly while cutting is being performed.
- **ALWAYS** use the manufacturer's recommended grounding techniques when using a portable generator to provide power to the unit. Read the generator operator's manual and safety instructions carefully before using a generator to provide power.
- **NEVER** touch the gear housing, blades, or any other metal part on the hedge trimmer if the blades have nicked or cut into the power cord. Shut off the power, set the unit down carefully, and disconnect the power cord at the power outlet before freeing the cord from the hedge trimmer blades.
- **ALWAYS** check the extension cord and power cord for signs of wear, cuts, or other damage before use, and replace cord if any damage is present.
- **ALWAYS** wind up the extension cord and store safely when cutting is completed. Leaving an extension cord on the ground is a hazard, and can cause trips and falls, even when left out in plain view.



# ELECTRIC HEDGE TRIMMERS

ENGLISH

## ELECTRIC POWER OPERATING SAFETY

### DANGER

*Misuse of electrically powered products, or failure to follow all safety precautions and operating instructions, can result in electrical burns, shock, electrocution, and serious or fatal injuries from explosion or fire.*

Obey these important warnings when using electrically-powered tools and equipment:

- **NEVER** operate an electric hedge trimmer, or any other electrical power equipment, in the rain, in wet locations, or anywhere else the operator may come into contact with water or wet surfaces. Water conducts electricity, and provides a path to ground if touched or stepped on.
- **NEVER** use electric hedge trimmers to cut wet hedges or shrubbery.
- **NEVER** operate the unit if the housing is cracked, wires are frayed, or sparks from cords or connections are noticed when the unit is turned on. Turn off the power to the power outlet immediately, disconnect the power cord, and have the unit thoroughly inspected and serviced before using it again.
- **STOP** using the unit immediately if the power cords, plugs, receptacles become hot to the touch, if you notice a burning smell, or if you see smoke coming from the power cords or hedge trimmer. Turn off the power to the power outlet immediately, and carefully disconnect the power cord. Allow the unit to cool before handling, and have the unit inspected and serviced before using it again.
- **NEVER** operate electric hedge trimmers around gasoline, flammable paints, stains, solvents, thinners, and adhesives, or any type of explosive gas or vapor. Electric motors emit sparks which can ignite flammables and vapors, causing serious injuries and property damage from explosion and fire.
- **NEVER** plug unit in without first checking ON-OFF switch to make sure unit is in OFF position. Unintentional starting of unit can result in serious injury.
- **NEVER** tape or tie the ON-OFF switch in the ON position to lock the unit ON. Using a unit with switch locked in the ON position can result in serious injury to operator and others.
- **NEVER** leave a plugged-in unit unattended. A child or other inexperienced person could pick up the unit and seriously injure themselves or someone else.



**Danger:**  
**Broken Guard**  
**Cracked Housing**

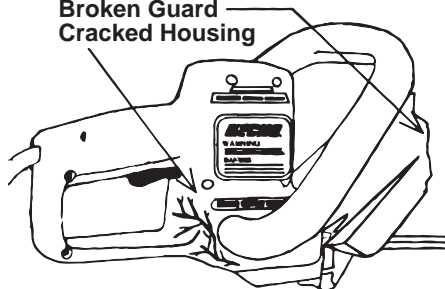

<b>Key Hedge Trimmer Terms</b>	
<b>Term</b>	<b>Definition</b>
Air Filter	Filters air used by the engine for combustion. Keeps dirt and dust out of the engine to help extend engine life.
ANSI Z87.1	American National Standards Institute safety standard for safety glasses. Safety glasses and goggles that meet the requirements of this standard are marked with this number.
Anti-vibration System	A design that minimizes the vibration created during operation. Reduced vibration helps reduce operator fatigue and risk of injury.
Blade Cover	Protective plastic cover used to prevent accidental contact with blades. Used when carrying, transporting, or storing hedge trimmers.
Blade Guard	Device used to prevent entry of improper or oversize material into blade teeth.
Blade Pitch	The distance between blade teeth.
Blades	Toothed cutting devices that are used to cut shrubs, bushes, and other vegetation.
Carburetor	Mixes fuel and air together so combustion can take place in engine.
Catalytic Muffler	Reduces noise and emissions.
Choke Control Lever	Controls choke open/closed settings. Used for starting/running engine. Also used for emergency stops.
Clutch	Device that transmits rotary motion of crankshaft to the gear case assembly.
Clutch Engagement Speed	The engine speed or R.P.M. at which the clutch engages and transmits power to the gear case.
Double Reciprocating Blade	A hedge trimmer with two blades that move over one another in a back and forth motion.
Double-sided blade	Hedge trimmer blade that has cutting teeth on both sides of blade assembly. Allows cutting action in two directions.
Emergency Stop Procedure	Procedure used to stall engine if Stop switch malfunctions and unit does not stop when switch is moved to stop position. Move choke lever to Cold Start (Choke) position to stall engine.
Face Mask	Protective device worn over mouth and nose. Protects against breathing sawdust or other small particles.
Face Shield	Protective device worn over safety glasses or safety goggles to provide face protection from flying debris.

# GLOSSARY

Foot Protection	Heavy-duty footwear that protects the feet from injury.
Front Handle	Provides secure support of unit for proper balance and control. Helps reduce operator fatigue.
Fuel Filter	Filter element located on end of fuel line. Filters fuel mix before it enters carburetor.
Fuel Tank	Contains fuel mix used for engine operation.
Gear Case	Provides reciprocating motion to hedge trimmer blades.
GFCI	Ground Fault Circuit Interrupter - An electrical circuit breaker that provides protection from shocks.
Hand Guard	Protective device that prevents hands from contacting blades.
Head Protection	Helmet-like device that protects the head from falling materials.
Hearing Protection Devices	Protective devices such as ear plugs or ear muffs that protect hearing by reducing exposure to harmful noises.
Idle Speed	The normal running speed of the engine when the throttle trigger is not depressed.
Jamming	Stopping of blades caused by a restriction. May result from an obstruction, cutting branches that are too thick, or feeding blades into material too quickly.
Lockout Switch	Prevents operation unless handle is properly held by operator. Helps keep hands away from blades.
Maximum Diameter Cut	The largest diameter material that can be cut by the hedge trimmer blades.
Muffler Housing	Provides protective barrier around muffler. Helps prevent accidental contact with muffler when unit is hot.
Power Head	Engine assembly - includes engine, clutch, fuel system, ignition system, air filter, and recoil starter.
Protective Clothing	Clothing that provides protection from work place hazards that can cause cuts, scratches, or contact injuries.
Purge Bulb	Draws fuel mix from gas tank to carburetor. Helps engine to start by purging air from fuel line.
Rear Handle	Houses Stop Switch, Throttle Trigger, and Throttle Trigger lockout lever. Gripped by operator to help support unit, control engine speed, and shut unit off.
Recoil Starter	Starts engine by turning crankshaft and moving piston up and down.
Recoil Starter Handle	Molded rubber handle attached to starter cord. Used to start engine.

Safety Glasses	Eye protection devices that are worn like glasses.
Safety Goggles	Eye protection devices that fit flush against the face and cover the complete eye and socket.
Single Reciprocating Blade	A hedge trimmer with one fixed blade and one blade that moves back and forth over the fixed blade.
Single-sided blade	Hedge trimmer blade that has cutting teeth on one side of blade assembly. Cuts in one direction only.
Spark Arrestor Muffler	Muffler with spark arrestor screen that prevents hot, glowing particles of carbon from leaving the muffler.
Spark Plug	Provides spark to ignite fuel/air mixture in engine.
Stalling Engine	Using choke lever to provide an overly rich fuel/air mixture that stops engine from running.
Stop Switch	Electrical switch used to start/stop engine. Grounds ignition circuit in Stop position to prevent firing of spark plug.
Throttle Trigger	Controls engine speed
Throttle Trigger Lockout Lever	Prevents the throttle trigger from operating unless lockout lever is depressed
Wide Open Throttle	The highest engine speed attainable when the throttle trigger is held fully depressed.
Wire Gauge	A term used to describe the wire diameter used in electrical power cords.
Wire Gauge Table	Table that shows the minimum wire gauge and maximum cable lengths that can safely handle the current used by an electrical device such as an electric hedge trimmer.

To locate your nearest ECHO dealer visit our website,

<http://www.echo-usa.com>,

or call 1-800-432-ECHO (3246).

Ask how to obtain a FREE Safety Video. Echo's Supplemental Safety Video provides helpful safety and cutting information.

To locate your nearest Shindaiwa dealer visit our website,

<http://www.shindaiwa-usa.com>,

or call 1-877-986-7783.

Ask how to obtain a FREE Safety Video. Shindaiwa's Supplemental Safety Video provides helpful safety and cutting information.



**ECHO INCORPORATED**

**400 OAKWOOD ROAD**

**LAKE ZURICH, IL 60047**

**PHONE: (847) 540-8400**

**[www.echo-usa.com](http://www.echo-usa.com)**