



ESP-ME3 Controller User Manual



Introduction	3
Welcome to Rain Bird.....	3
The Intelligent Use of Water®	3
ESP-ME3 Controller Features.....	3
WiFi Enabled.....	3
Installation	4
Mount Controller	4
Connect Valves	4
Connect Master Valve (optional).....	4
Connect Pump Start Relay (optional).....	5
Connect Flow Sensor (optional).....	5
Connect Weather Sensor (optional).....	6
Connect Power	6
Station Expansion Modules.....	7
Install Modules	7
Station Numbering	8
Complete Controller Installation	8
Normal Operation	8
Controls and Features.....	8
AUTO	9
OFF.....	9
Display Indicators	9
Basic Programming	10
1. Set Date and Time	10
2. Set Watering Start Times	10
3. Set Station Run Times	10
4. Set Water Days.....	10
Custom Days of the Week.....	10
Program-Based Scheduling	11
Common Programming Error	11
Manual Watering Options	11
Test All Stations.....	11
Run a Single Station	11
Run a Single Program	12
Advanced Programming	12
Odd or Even Calendar Days	12
Cyclic Days.....	12
Seasonal Adjust.....	13
Delay Watering	13
Permanent Days Off	13
Special Features	14
Options	14
Reset Button	14
Remote Accessories.....	14
Detached Programming.....	15
Battery Life.....	15

Appendix	15
Troubleshooting	15
Error Detection	15
Programming Errors (blinking LED)	15
Electrical Errors (non-blinking LED)	15
Flow Alarms	16
Watering Issues.....	16
Electrical Issues (solid LED illuminated).....	17

Hazardous Warnings

WARNING

Indicates a hazardous situation that, if not avoided, could result in death or serious injury.

CAUTION

Indicates a hazardous situation that, if not avoided, could result in minor or moderate injury.

NOTICE

Indicates information considered important, but not hazard-related (e.g., messages relating to property damage).

SAFETY INSTRUCTIONS

Specific safety-related instructions or procedures are described.

Symbols & User Operation

 **NUMBERS** define a series of steps for the user to follow in order to operate the controller.



NOTE: Notifies the user of important operating instructions related to controller functionality, installation or maintenance.



REPEAT: Indicates that a repetition of previous steps or actions may be required for further operation, or to complete a process.

Technical Support

Questions?

Call Rain Bird toll free Technical Support at
1-800-724-6247 (USA and Canada only)

Introduction

Welcome to Rain Bird

Thank you for choosing Rain Bird's ESP-ME3 controller. In this manual are step by step instructions for how to install and operate the ESP-ME3.



The Intelligent Use of Water®

We believe it is our responsibility at Rain Bird to develop products that use water efficiently.

ESP-ME3 Controller Features

Feature	Description
Maximum Stations	22 (with optional Station Modules)
Master Valve or Pump Start Relay	Supported
Start Times	6
Programs	4
Program Cycles	Custom Days, Odd, Even and Cyclic
Permanent Days Off	By program
Master Valve Control	On/Off per station
Rain Delay	Supported
Rain/Freeze Sensor	Supported
Rain Sensor Control	Global or by station
Seasonal Adjust	Global or by program
Manual Watering Run	Yes
Manual Program Run	Yes
Manual Test All Stations	Yes
Short Detect	Yes
Delay Between Stations	Set by program
Accessory Port	Yes (5 pin)
Save & Restore Programming	Yes
Station Advance	Yes
LNK™ WiFi Module	Supported
Flow Sensor	Supported
Cycle+Soak™	Supported in Rain Bird App via LNK™ WiFi Module

WiFi Enabled

The **LNK™ WiFi Module** allows remote connection to a Rain Bird ESP-ME3 Controller using an Apple iOS or Android compatible smart device. The mobile application allows remote access and configuration of one or more irrigation controllers.

For more information on the LNK™ WiFi Module and the value this product can provide for your ESP-ME3 controller, please visit: <http://wifi-pro.rainbird.com>

LNK™ WiFi Module
(sold separately)

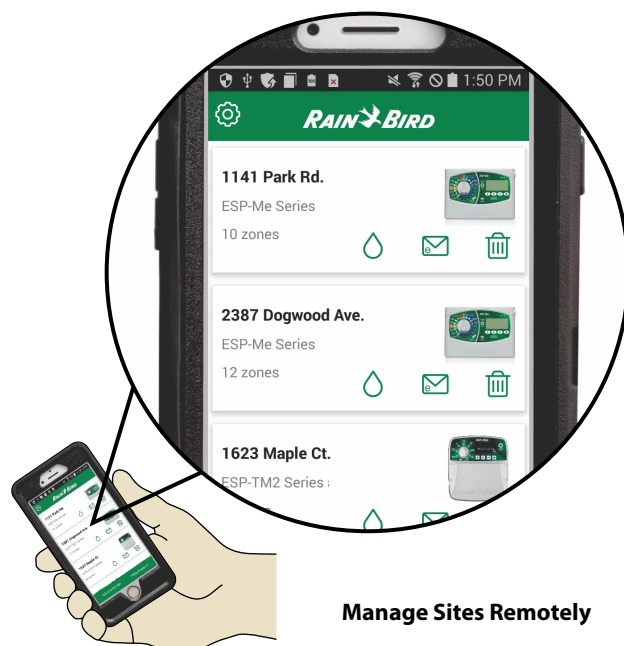

Manage Sites Remotely

Installation

Mount Controller

 **NOTE:** Choose a suitable mounting location close to a 120VAC wall outlet.

- 1 Drive a mounting screw into the wall, leaving an 1/8 inch gap between the screw head and the wall surface (use the supplied wall anchors if necessary), as shown.
- 2 Locate the keyhole slot on back of the controller unit and hang it securely on the mounting screw.

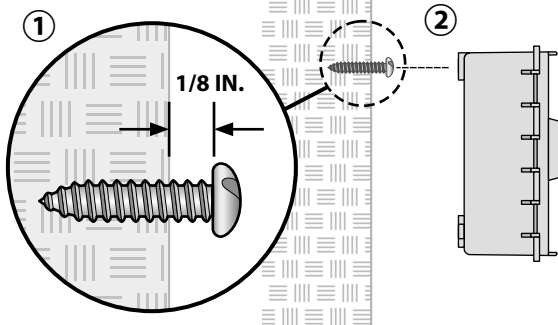

- 3 Open the front panel, and drive three additional screws through the open holes inside the controller and into the wall, as shown.

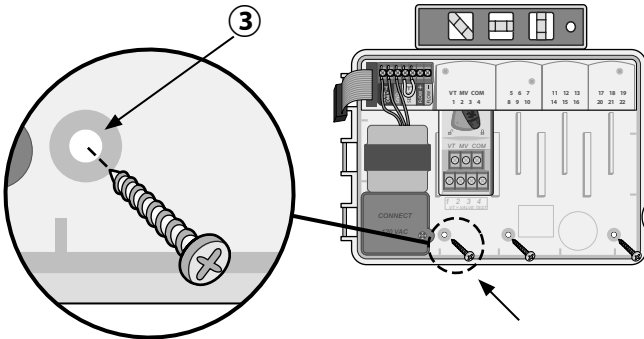

Connect Valves

- 1 Route all field wires through the opening at the bottom or back of the unit. Attach conduit if desired, as shown.

WARNING

Do not route valve wires through the same opening as power wires.

- 2 Connect one wire from each valve to the terminal on the **Base Module** or **Station Module** that corresponds to the desired station number (1-22).
- 3 Connect a field common wire to the **COM** (common) terminal on the **Base Module**. Then connect the remaining wire from each valve to the field common wire, as shown.
- 4 To perform a Valve Test, connect the common wire to the **COM** terminal and the power wire to the **VT** terminal. This will immediately turn the valve ON.

Connect Master Valve (optional)

- 5 Connect a wire from the master valve to the **MV** (master valve) terminal on the **Base Module**. Then connect the remaining wire from the master valve to the field common wire, as shown.

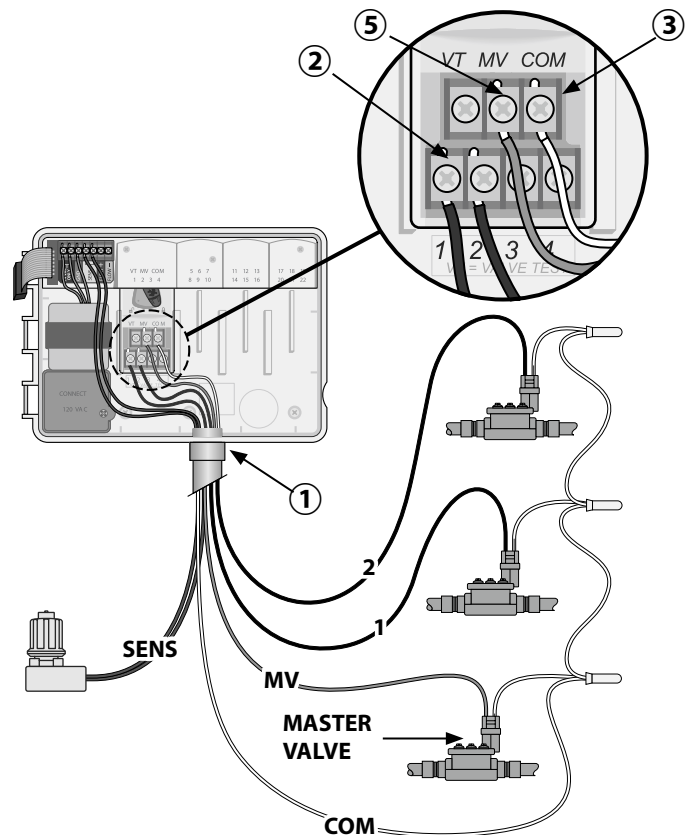

Connect Pump Start Relay (optional)

- 1 Connect a wire from the **PSR** (pump start relay) to the **MV** (master valve) terminal on the **Base Module**. Then connect another wire from the pump start relay to the field common wire, as shown.
- 2 To avoid the possibility of damage to the pump, connect a short jumper wire from any unused terminal(s) to the nearest terminal in use, as shown.

NOTICE

The ESP-ME3 controller DOES NOT provide power for a pump. The relay must be wired according to manufacturer instructions.

Only the following Rain Bird pump start relay models are compatible with the ESP-ME3:

Description	Note	Model No.
Universal Pump Relay	110 volt only	PSR110IC
Universal Pump Relay	220 volt only	PSR220IC

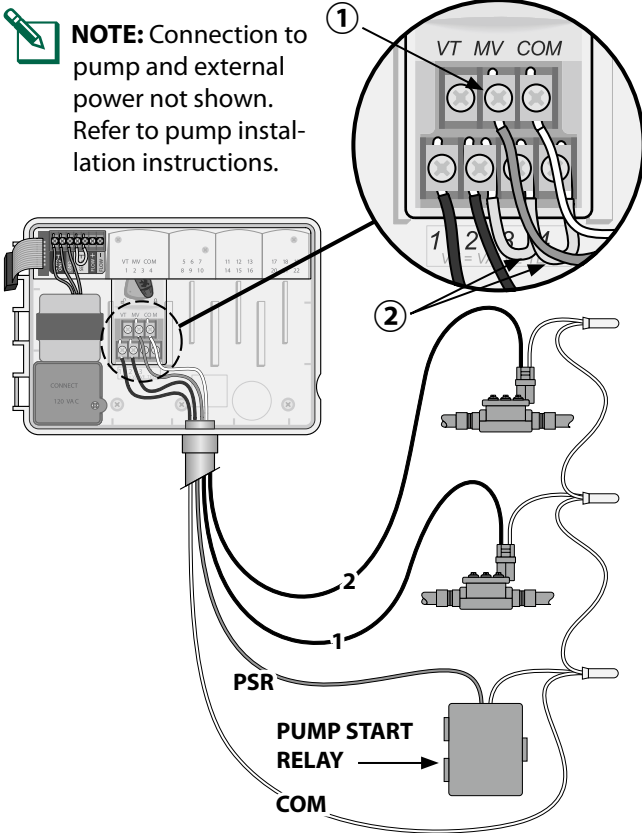

NOTE: Connection to pump and external power not shown. Refer to pump installation instructions.

Connect Flow Sensor (optional)

- NOTE:** Install the flow sensor in the field according to the manufacturer's instructions.
- 1 Run the flow sensor wires to the controller.

WARNING

Do not route valve wires through the same opening as power wires.

- 2 Connect both flow sensor wires to the **Flow** terminals, as shown. Be sure to connect the positive (sometimes red) sensor wire to the red (+) terminal and the negative (sometimes black) sensor wire to the grey (-) terminal.

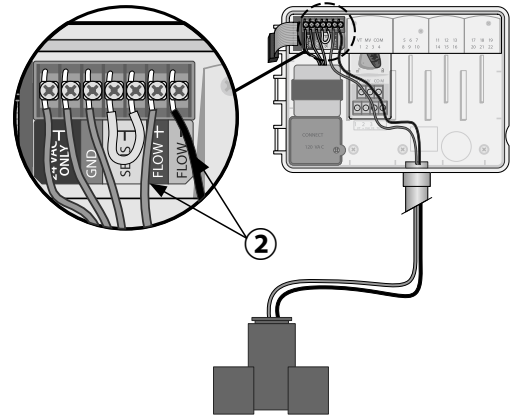

Flow Sensor Settings

Set the controller to obey or ignore a flow sensor.

When set to **Sensor ON**, automatic irrigation will be suspended per station if detected flow exceeds learned flow by more than 30%. When set to **Sensor OFF**, all stations will ignore the flow sensor.

Turn the dial to **Flow Sensor**.

- Press **-** or **+** to select **SENS ON** (sensor on) or **SENS OFF** (sensor off).



NOTE: When switching from **Sensor OFF** to **Sensor ON**, the controller will begin to LEARN FLOW. It will run each station for short period to set the expected station flow.

NOTE: See Troubleshooting section of the Appendix for Flow Alarms information.

Connect Weather Sensor (optional)

- 1 Remove the yellow jumper wire from the **SENSOR** terminals on the controller.

NOTICE

Do not remove the yellow jumper wire unless connecting a rain sensor.

- 2 Connect both rain sensor wires to the **SENSOR** terminals as shown.

WARNING

Do not route the rain sensor wires through the same opening as the power wiring

 **NOTE:** Rain Bird ESP-ME3 controllers are only compatible with normally closed rain sensors.

 **NOTE:** For wireless rain/freeze sensors, refer to the sensor installation instructions.

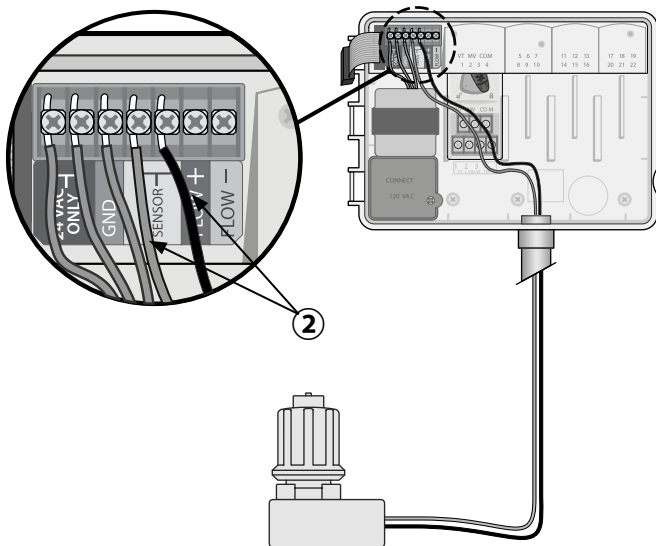

Weather Sensor Settings

Set the controller to obey or ignore a weather sensor.

When set to **Sensor ON**, automatic irrigation will be suspended if rainfall is detected. When set to **Sensor OFF** all stations will ignore the rain sensor.



Turn the dial to **Weather Sensors**.

- Press **—** or **+** to select **SENS ON** (sensor on) or **SENS OFF** (sensor off).



Sensor ON



Sensor OFF



Rain detected
(flashing)

Connect Power

WARNING

DO NOT plug in the transformer or connect external power until you have completed and checked all wiring connections.

Installation with Pre-attached Cord

- Plug the attached power cord into a nearby 120VAC electrical outlet.

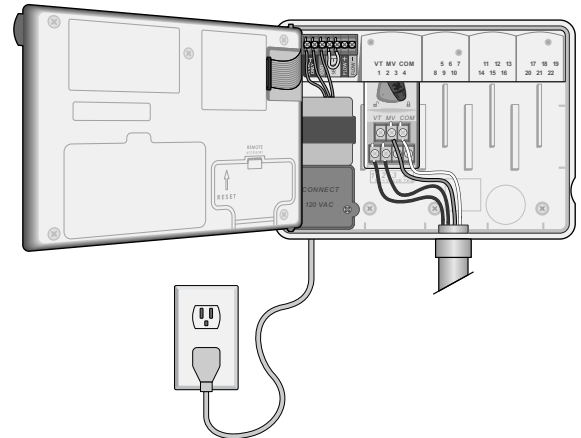

Outdoor Installation with Direct Wiring

⚠ WARNING

Electric shock can cause severe injury or death. Make sure power supply is turned OFF before connecting power wires.

POWER WIRING CONNECTIONS

Black supply wire (hot) to the black transformer wire

White supply wire (neutral) to the white transformer wire

Green supply wire (ground) to the green transformer wire

- 1 Locate the transformer wiring compartment in the lower left corner of the controller unit. Use a screwdriver to remove the cover and expose the transformer connection wires.
- 2 Route the three external power source wires through the conduit opening at the bottom of the unit and into the wiring compartment.
- 3 Using the provided wire nuts, connect the external power source wires (two power and one ground) to the transformer connection wires inside the wiring compartment.

⚠ WARNING

Ground wire must be connected to provide electrical surge protection. Permanently mounted conduit shall be used for connecting main voltage to the controller

- 4 Verify that all wiring connections are secure, then replace the wiring compartment cover and secure it with the screw.

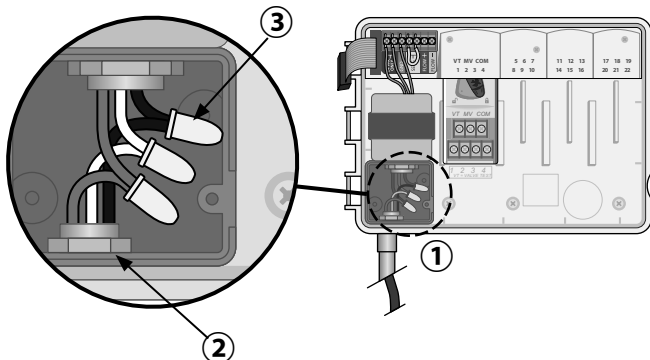

Station Expansion Modules

Optional Station Modules can be installed in the empty slots to the right of the Base Module to increase the station capacity up to 22 stations.

 **NOTE:** 6-Station Modules are compatible with ESP-ME3 and ESP-Me. They are not backwards compatible with the ESP-M vintage controller.

 **NOTE:** For ideal station sequencing, insert 3-Station module after inserting all 6-station modules. For more details see the Station Numbering section.

Base Module
(included)



Expansion Modules
(sold separately)



3-STATION
(ESPSM3)

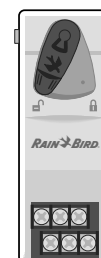



6-STATION
(ESPSM6)

Install Modules

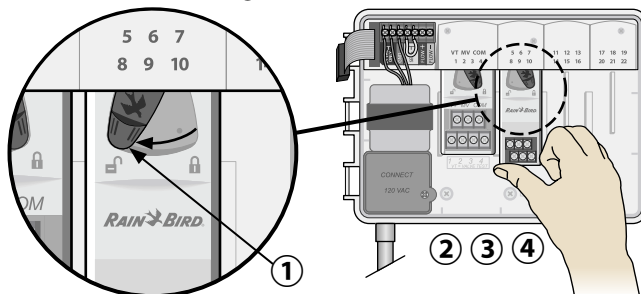
- 1 Verify the securing lever on the module is in the unlocked position (slide to the left).
- 2 Place the module under the desired slot between the plastic rails.
- 3 Push the module up into the slot until secure.
- 4 Slide the securing lever to the locked position (slide to the right).



 **REPEAT** for additional modules.

 **NOTE:** Modules can be installed or removed with OR without AC power connected. They are considered "hot-swappable".

 **NOTE:** It take about 30 seconds for stations to become available for configuration after installing a new module.

Station Numbering

The controller is configured with “fixed station numbering”, meaning that Bays Two, Three and Four can accept either a 3 or a 6-Station Module. If a 6-Station Module is NOT installed then the unused stations are reserved for future use.

Example of Station Numbering when using two 3-Station Modules. A total of 10 stations are installed.

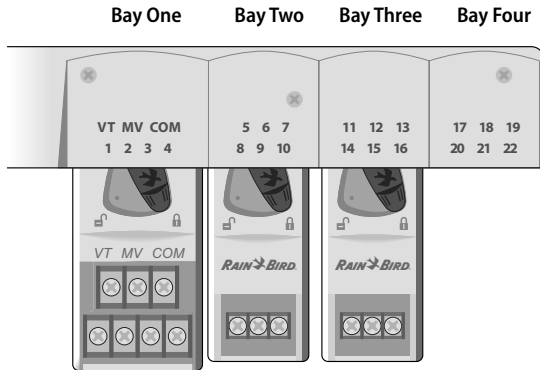

- The **Base Module** is installed in **Bay One** and uses Stations 1 through 4.
- A **3-Station Module** is installed in **Bay Two** and uses stations 5 through 7. Stations 8 through 10 are skipped and will be unavailable.

- A **3-Station Module** is installed in **Bay Three** and uses stations 11 through 13.

During programming, the controller will skip any unused stations, creating a gap in station numbering. The unused stations will show on the display as **8SKIP**, **9SKIP**, etc.



If the screen displays **20NOMOD** where the 20 is flashing, then there is no module installed for that station number.

Complete Controller Installation

- 1 Reinstall and reconnect the front panel.
 - 2 Apply power to the controller and test the system.
- NOTE:** The electrical connections can be checked even if water is not available. If water is available and you would like to test some or all of your stations, use the **Test All Stations** feature of the controller.

Normal Operation

Controls and Features

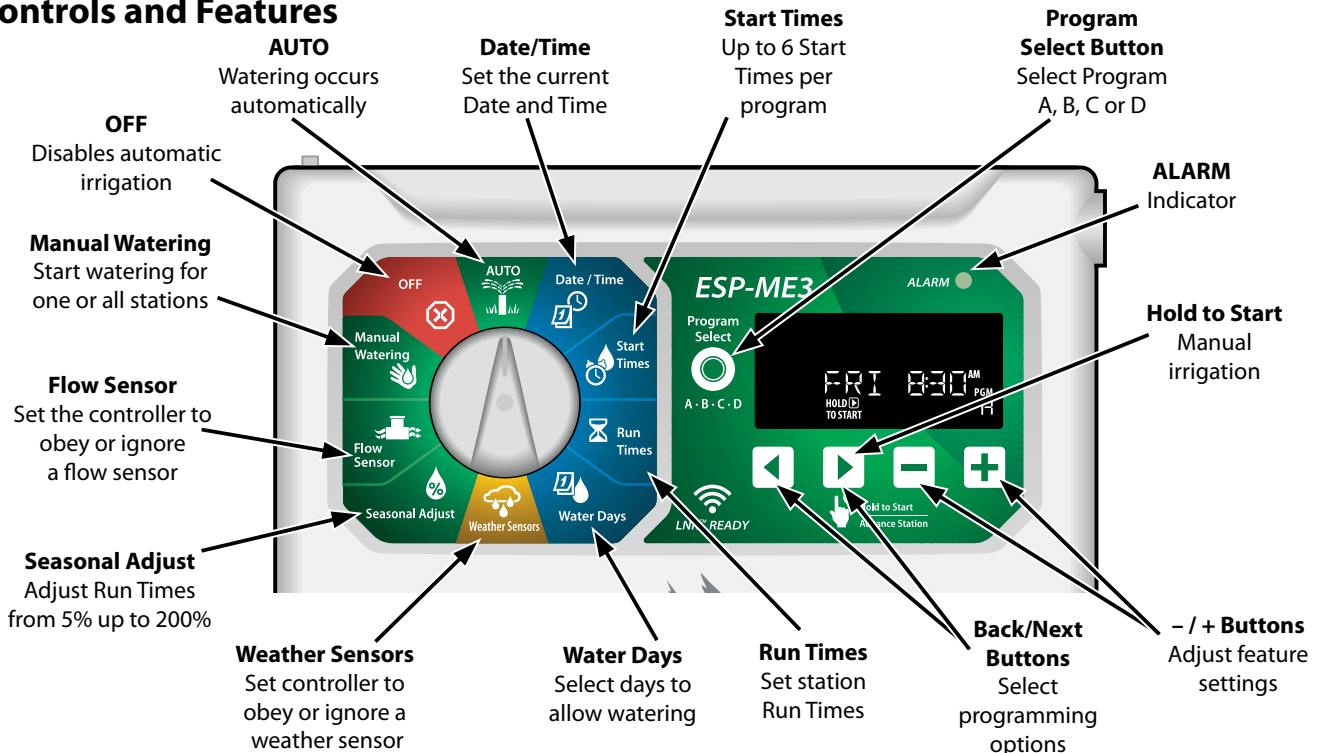



AUTO

AUTO is the normal operating mode. Return the dial to **AUTO** when programming is complete.

During Watering:

The display shows a blinking sprinkler symbol, the active Station Number or Program, and the Remaining Run Time.

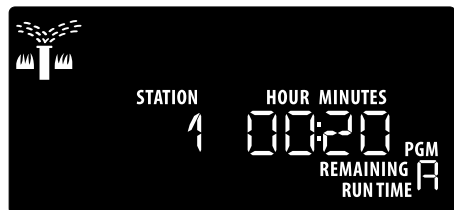

- To cancel watering, turn the dial to **OFF** for three seconds until the screen shows OFF.

To Manually Start a Program:

- 1 Press the **Program Select** button to select a program.
- 2 Press and hold the **Hold to Start** button to immediately start manual watering for the selected program.

Program
Select
A · B · C · D

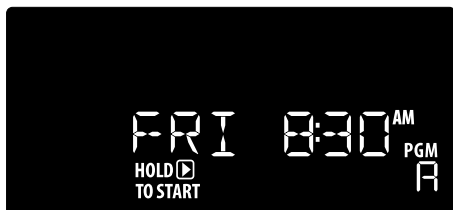

Hold to Start
Advance Station



OFF

Turn the dial to **OFF** to stop automatic irrigation or to cancel all active watering immediately.

NOTICE

Watering will NOT occur if the controller remains in the OFF position.



NOTE: Manual watering can be started using mobile apps or LIMR when dial is in OFF position.

Display Indicators

Display	Function	Description
ALL	ALL	All stations
CLEARED	CLEARED	Programming was cleared
CYCLIC	CYCLIC	Watering occurs at specific intervals, such as every 2 days
DELAY	DELAY	Delay Watering Active
EVEN	EVEN	Even days watering
FLOW	FLOW	Flow Sensor
MV ON	MV ON	Master or Pump-start relay is active
NOMOD	NOMOD	No station modules installed for that station
ODD	ODD	Odd days watering
OFF	OFF	Controller will not water
PERMOFF	PERMOFF	Permanent days off for Odd, Even, Cyclic watering
RAIN	RAIN	Rain Sensor
RESTORD	RESTORD	Programming restored
SAVE	SAVED	Save programming
SENS ON	SENS ON	Sensor will function if wired
SEN OFF	SEN OFF	Sensor is ignored even if wired
SKIP	SKIP	Station not used due to station module configuration
SOAK	SOAK	Soak time between watering times - supported through the Rain Bird app.

Basic Programming

1. Set Date and Time



Turn the dial to **Date / Time**

- ① Press ◀ or ▶ to select the setting to change.
- ② Press — or + to change the setting value.
- ③ Press and hold — or + to accelerate adjustments.

To change the time format (12 hour or 24 hour):

- ① With **Day of Month** blinking, press ◀.
- ② Press — or + to select the desired time format, then press ▶ to return to the date setting.

2. Set Watering Start Times

Up to six Start Times are available for each program.



Turn the dial to **Start Times**

- ① Press **Program Select** to choose the desired Program (if necessary).
- ② Press ◀ or ▶ to select an available **Start Time**.
- ③ Press — or + to set the selected **Start Time** (ensure the AM/PM setting is correct).
- ④ Press ▶ to set additional **Start Times**.



NOTE: The OFF Position for any start time is between 11:45 PM and 12:00 AM.

3. Set Station Run Times

Run Times can be set from one minute up to six hours.



Turn the dial to **Run Times**

- ① Press **Program Select** to choose the desired Program (if necessary).
- ② Press ◀ or ▶ to select a **Station**.
- ③ Press — or + to set the **Run Time** for the selected Station.
- ④ Press ▶ to set additional Station Run Times.



NOTE: Only assign Run Times in a Program for stations you want to water. If you do not want a specific station to run in a selected program then set the Run Time to zero.



NOTE: Rain Bird recommends that the maximum irrigation station cycle time be less than the time required for runoff to begin and that there be adequate soak time before the next irrigation cycle of that same station begins again.

4. Set Water Days

Custom Days of the Week

Set watering to occur on specific days of the week.



Turn the dial to **Water Days**

- ① Press **Program Select** to choose the desired Program (if necessary).
- ② Press — or + to set the selected (blinking) day as either **ON** or **OFF**, and to automatically move to the next day.
- ③ Press ◀ or ▶ at any time to move the cursor to the previous or next day.



NOTE: With Sunday selected, press the ▶ button to enter and activate Cyclic Watering (see the **Advanced Programming** section). If this is not desired, press the ◀ button to return to watering by Custom Days.

Program-Based Scheduling

The ESP-ME3 uses a programmed-based scheduling method to create irrigation schedules. This means all stations with a run time on the program will run in numerical order.

Common Programming Error

The most common programming error for any program-based controller is to set multiple Program Start Times that cause watering cycles to repeat.

As an example: Program A has a 1st Start Time set to run at 8:00 AM. But then a 2nd Start Time has mistakenly been set for 8:15 AM, which means that all stations would water a 2nd time.

In this example, a 3rd Start Time has mistakenly been set for 8:30 AM. Which means all stations would water a 3rd time. The desired watering time was 45 minutes, or 15 minutes per station. The actual is 2 hours and 15 minutes, which is excessive watering!

Incorrect: Multiple Start Times set by mistake

Program Letter	Program Watering Time	Program Start Time	Station Number	Station Watering Duration
A	1st	8:00 AM	1	15 MIN
			2	15 MIN
			3	15 MIN
A	2nd	8:15 AM	1	15 MIN
			2	15 MIN
			3	15 MIN
A	3rd	8:30 AM	1	15 MIN
			2	15 MIN
			3	15 MIN

Correct: Only one Start Time

Program Letter	Program Watering Time	Program Start Time	Station Number	Station Watering Duration
A	1st	8:00 AM	1	30 MIN
			2	30 MIN
			3	30 MIN
			4	30 MIN

Manual Watering Options

Test All Stations

Start watering immediately for all programmed stations.



Turn the dial to **Manual Watering**

- 1 Press **—** or **+** to set a **Run Time**.
- 2 Press the **Hold to Start** button.
- 3 Turn the dial to **AUTO** after display shows **STARTED**.

During Testing:

The display shows a blinking sprinkler symbol, the active Station Number and the remaining Run Time.



- 4 To cancel the test, turn the dial to **OFF** for three seconds until the screen shows OFF.

Run a Single Station

Start watering a single station, or set multiple stations to water in order.



Turn the dial to **Manual Watering**

- 1 Press **◀** or **▶** to select the desired station.
- 2 Press **—** or **+** to set a **Run Time**.
- 3 Press the **Hold to Start** button.
- 4 Irrigation will begin and **STARTED** will appear on the display.
- 5 Turn the dial back to **AUTO**



REPEAT process as desired to add more stations to the queue. When one station finishes watering then the next station will start.



NOTE: Manual Watering (Test All, Run Single Station and Manual Program) will start even when a weather sensor is set to **SENS ON** (sensor on).

Run a Single Program

Start watering immediately for one program.



Turn the dial to **AUTO**.

- ① Press **Program Select** to choose the desired Program (if necessary).
- ② Press the **Hold to Start** button to begin watering the selected Program.
- ③ Irrigation will begin and **STARTED** will appear on the display.
- ④ Press the **Advance Station** button to advance to the next station if desired.



NOTE: A maximum of 88 stations can be queued across all four programs.

During Manual Watering (Single-station or Single-program):

The display shows a blinking sprinkler symbol, the active Station Number, and the remaining Run Time.

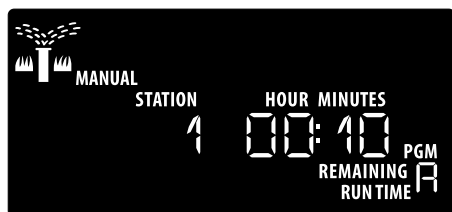

- To cancel manual watering, turn the dial to **OFF** for three seconds until the screen shows OFF.

To add additional programs to the manual watering queue:



Turn the dial to **Manual Watering**

- ① Press and hold **Program Select** to show program letter on the display.
- ② Press **Program Select** to choose the desired program (if necessary).
- ③ Press the **Hold to Start** button to begin watering the selected program.
- ④ Turn the dial to **AUTO**

Advanced Programming

Odd or Even Calendar Days

Set watering to occur on all ODD or EVEN calendar days.



Turn the dial to **Water Days**

- ① Press **Program Select** to choose the desired Program (if necessary).
- ② Press and hold and until **ODD** or **EVEN** is displayed.

Cyclic Days

Set watering to occur at specific intervals, such as every 2 days, or every 3 days, etc.



Turn the dial to **Water Days**

- ① Press **Program Select** to choose the desired Program (if necessary).
- ② On the **Custom Days of the Week** screen, press until the **Cyclic** screen is displayed (after SUN).
- ③ Press or to set the desired **DAY CYCLE**, then press .
- ④ Press or to set the **DAYS REMAINING** before the cycle begins. The **NEXT** watering day updates on the display to indicate the day that watering will start as shown.



NOTE: See **Special Features** to set Rain Sensor ON by Station.

Seasonal Adjust

Increase or decrease program run times by a selected percentage (5% to 200%).

As an example: If the Seasonal Adjust is set to 100% and the station Run Time is programmed for 10 minutes, the station will run for 10 minutes. If the Seasonal Adjust is set to 50%, the station will run for 5 minutes.

 Turn the dial to **Seasonal Adjust**.

- ① Press **—** or **+** to increase or decrease **Seasonal Adjust** for all Programs.
- ② To adjust an individual Program, press **Program Select** to choose the desired Program (if necessary). Press **—** or **+** to increase or decrease **Seasonal Adjust** for all Programs.

Delay Watering

Suspend watering for up to 14 days.

 Turn the dial to **AUTO**.

- ① Press and Hold the **+** button to enter the **Rain Delay** screen.
- ② Press **—** or **+** to set the **DAYS REMAINING**. The **NEXT** watering day will update on the display to indicate when watering will resume.

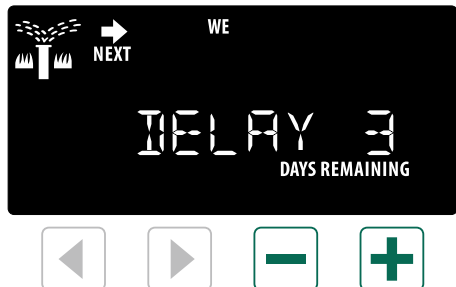

- ③ To cancel a Rain Delay, set the **DAYS REMAINING** back to 0.

 **NOTE:** When the delay expires, automatic irrigation resumes as scheduled.

Permanent Days Off

Prevent watering on selected days of the week (for Odd, Even or Cyclic programming only).

 Turn the dial to **Water Days**

- ① Press **Program Select** to choose the desired Program (if necessary).
- ② Press and hold **Program Select**, then press **—** to set the selected (blinking) day as a **Permanent Day Off** or press **+** to leave the day **ON**.



Special Features

- 1 Turn the dial to the desired position indicated below for each **Special Feature**.
- 2 Press and hold ◀ and ▶ at the same time.

Set Interstation Delay by Program

A station delay (from 1 second to 9 hours) ensures that a valve has completely closed before the next one opens. Press Program Select to set delay for different programs.

Set Flow Sensor by Station

Turns a flow sensor on or off by station

Reset to Factory Defaults

All programmed schedules will be erased.

Set Rain Sensor by Station

Tells a station to obey or ignore a rain sensor.

Set to Odd or Even Watering Days

Set Master Valve by Station

Allows a station to be controlled by a master valve or pump start relay.

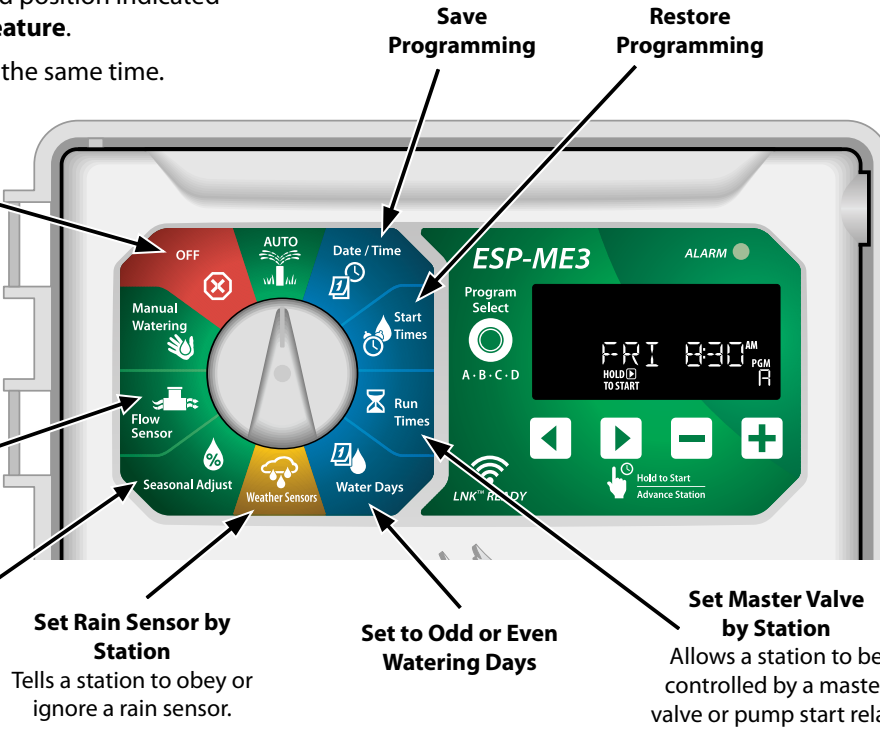

Options

Reset Button

If the controller is not working properly, you can try pressing RESET.

- Insert a small tool such as a paper clip, into the access hole and press until the controller is reset. All previously programmed watering schedules will remain stored in memory.

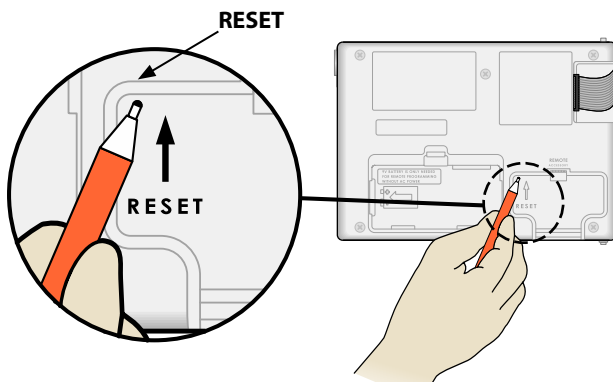

Remote Accessories

A 5 pin accessory port is available for Rain Bird approved external devices, including:

- LNK™ WiFi Module
- LIMR Receiver Quick Connect harness

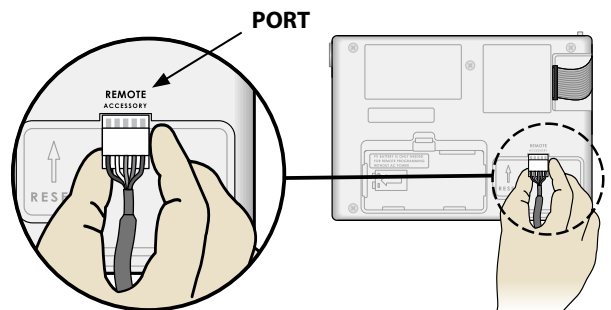



Detached Programming

Program the front panel remotely on battery power.

The front panel can be removed from the controller and programmed remotely using a 9 volt battery for power. Settings can be programmed for all 22 stations regardless of which Station Modules are installed in the controller.

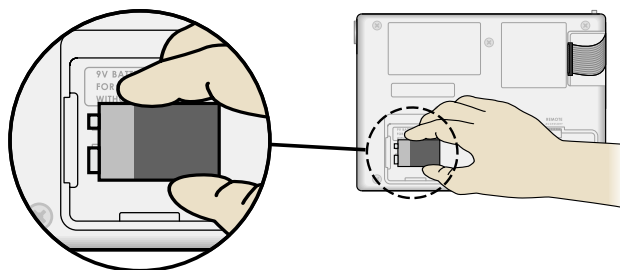
- ① Remove the front panel.
- ② Install a 9V battery in the battery compartment.
- ③ Program the controller.



 **NOTE:** Program information is stored in nonvolatile memory so it is never lost if the front panel loses power.

- ④ Replace the front panel (refer to **Complete Installation** in the Installation section).

 **NOTE:** After the front panel is re-installed, any station that does not have a corresponding Station Module installed will function as though the run time is zero.

Battery Life

If the display repeatedly shows "-- -- -- --", or there is no display when using a 9V battery for remote programming, replace the battery.

Appendix

Troubleshooting

Error Detection

The ESP-ME3 controller has built-in error detection that can automatically generate an **ALARM** caused by an essential programming error or if an electrical short condition is detected.

The **ALARM** LED light on the ESP-ME3 controller front panel will light up to indicate an alarm condition:

Programming Errors (blinking LED)

Error	ALARM LED	Error Message On Display
No Start Times are set	BLINK	NO START TIMES
No Run Times are set	BLINK	NO RUN TIMES
No Water Days are set	BLINK	NO WATER DAYS

The error will go away when the station is successfully run after condition is corrected.

 **NOTE:** The dial must be in the AUTO position for an ALARM message to appear on the display.

Electrical Errors (non-blinking LED)

Error	ALARM LED	Error Message On Display
Master Valve short	SOLID	MASTER VALVE SHORTED OR HIGH CURRENT
Station short	SOLID	STATION "X" WIRE SHORTED

When an electrical error is detected, irrigation for the affected station is cancelled and watering advances to the next operable station in the program.

The controller will attempt to water the affected station again at the next scheduled watering. Completion of a successful watering will clear the error condition associated with that station.

Flow Alarms

Error	ALARM LED	Error Message On Display
Flow Sensor - High Flow Condition	Solid	HIGH FLOW ALARM STATION "X"
Flow Sensor - Low Flow Condition	Solid	LOW FLOW ALARM STATION "X"

When a flow sensor is in use the ESP-ME3 monitors for High Flow of 130% above regular learned flow. This percent limit can be adjusted in the Rain Bird App when used with LNK™ WiFi Module. If a High Flow condition is detected, a "High Flow Alarm" is shown at the display and the red alarm LED comes on. To clear the alarm press the "Hold to Start" right arrow button during the alarm message.

Low Flow conditions are also monitored. The limit for Low Flow is 70% below the learned flow unless changed in the Rain Bird App. A Low Flow alarm is shown at the controller display and the red alarm LED comes on.

To clear the alarm press the "Hold to Start" right arrow button during the alarm message.

 **NOTE:** Turning the flow sensor feature off and then back on will cause the controller to learn new flow levels and ignore previous error conditions.

 **NOTE:** If the flow sensor measures flow when the controller is not scheduled for watering, a "HIGH FLOW ZONE" alarm is shown on the display and the red alarm LED comes on. To clear the alarm press the "Hold to Start" right arrow button during the alarm message.

Watering Issues

Problem	Possible Cause	Possible Solution
Display shows a program is active, but system isn't watering.	Water source not supplying water.	Verify there is no disruption to the main water line and that all other water supply lines are open and functioning properly.
	Wiring is loose or not properly connected.	Check that field wiring and master valve or pump start relay wiring is securely connected at the controller and in the field.
	Field wires are corroded or damaged.	Check field wiring for damage and replace if necessary. Check wiring connections and replace with watertight splice connectors if needed.
	Loss of AC power.	When there is a power loss and a 9 volt battery is installed, the system does not irrigate but programs show as remaining active.
NO AC message on display.	No Power detected.	Check circuit breaker and that unit is plugged into socket or properly connected to power source.
	Controller may be plugged into a GFCI outlet or an outlet that is wired to a GFCI outlet.	Check power to the outlet or reset the circuit breaker.
It just rained and the alarm light is not illuminated, why?	This is normal operation. The ESP-ME3 does not consider the interruption of irrigation due to rainfall as an alarm condition.	This is normal operation.
Programmed schedules do not start.	Connected rain sensor may be activated.	Set Rain Sensor to Sensor OFF to ignore the rain sensor. If watering resumes, the sensor is operating properly and no further correction is needed.
	Connected rain sensor may not be operating properly.	Let the rain sensor dry out, or disconnect it from the controller terminal strip and replace it with a jumper wire connecting the two SENS terminals, or set to Sensor OFF.
	If no rain sensor is connected, the jumper wire connecting the two SENS terminals on the terminal strip may be missing or damaged.	Move dial position to Weather Sensors and set to Sensor OFF.
Too much irrigation	Multiple Start Times in the same program.	Separate start times are not required for each valve. A program only requires single start time in order to run all stations in that program.
	Multiple programs are running at the same time.	Review programming to assure that the same Station is not active in multiple Programs.
	Valve is malfunctioning.	Check to see if the ALARM light on the controller is lit solid, then repair or replace the valve if necessary.
	Seasonal Adjust setting is too high.	Set Seasonal Adjust to 100%.

Electrical Issues (solid LED illuminated)

Problem	Possible Cause	Possible Solution
Display is blank or frozen, the controller will not accept programming or is operating abnormally.	Power not reaching the controller.	Verify the main AC power supply is securely plugged in or connected and working properly.
	Controller needs to be reset.	Press the Reset Button. For details see "Reset Button" section.
	An electrical surge may have interfered with the controller's electronics.	Unplug the controller for 2 minutes, then plug it back in. If there is no permanent damage, the controller should accept programming and resume normal operation.
Automatic error detection indicates a problem by ALARM LED and an error message on display.	Short circuit or overload condition in valve, master valve or pump start relay wiring.	Identify and repair the fault in the wiring. Refer to compatible pump start relays. For details see "Connect Pump Start Relay" section.
LED is flashing or solidly illuminated but I see no message on the LCD.	Dial not in AUTO RUN position.	Turn dial to AUTO RUN position. Push Reset button or power cycle the controller.

Certifications

Federal Communications Commission



This device complies with part 15 of the FCC Rules. Operation is subject to the following two conditions: (1) This device may not cause harmful interference, and (2) this device must accept any interference received, including interference that may cause undesired operation.

This equipment has been tested and found to comply with the limits for a Class B digital device, pursuant to Part 15 of the FCC Rules. These limits are designed to provide reasonable protection against harmful interference in a residential installation. This equipment generates, uses and can radiate radio frequency energy and, if not installed and used in accordance with the instructions, may cause harmful interference to radio communications. However, there is no guarantee that interference will not occur in a particular installation. If this equipment does cause harmful interference to radio or television reception, which can be determined by turning the equipment off and on, the user is encouraged to try to correct the interference by one or more of the following measures:

- Reorient or relocate the receiving antenna.
- Increase the separation between the equipment and receiver.
- Connect the equipment into an outlet on a circuit different from that to which the receiver is connected.
- Consult the dealer or an experienced radio/television technician for help.

FCC Regulatory Safety Notice and IC Canada Statements

The Class B apparatus meets all requirements of the Canadian ISED (formerly IC) regulations - CAN ICES-3 (B)/NMB-3 (B).

Cet appareil de classe B respecte toutes les exigences de la réglementation canadienne ISED (anciennement IC)- CAN ICES-3 (B)/NMB-3 (B).

Safety Information

⚠ WARNING

Special precautions must be taken when valve wires (also known as station or solenoid wires) are located adjacent to, or share a conduit with other wires, such as those used for landscape lighting, other “low voltage” systems or other “high voltage” power.

Separate and insulate all conductors carefully, taking care not to damage wire insulation during installation. An electrical “short” (contact) between the valve wires and another power source can damage the controller and create a fire hazard.

All electrical connections and wiring runs must comply with local building codes. Some local codes require that only a licensed or certified electrician can install power. Only professional personnel should install the controller. Check your local building codes for guidance.

If the supply cord of an outdoor controller is damaged, it must be replaced by the manufacturer, its service agent or similarly qualified persons in order to avoid a hazard.

If the supply cord of an indoor controller is damaged, it must be replaced by a special cord or assembly available from the manufacturer or its service agent.

Outdoor controller shall be permanently connected to fixed wiring by a flexible cord, and have a cord anchorage. The cord anchorage shall relieve conductors from strain, including twisting, at the terminals and protect the insulation of the conductors from abrasion.

⚠ CAUTION

Stationary appliances not fitted with means for disconnection from the supply mains having a contact separation in all poles that provide full disconnection under overvoltage category III, the instructions state that means for disconnection must be incorporated in the fixed wiring in accordance with the wiring rules

NOTICE

Use only Rain Bird approved accessory devices. Changes or modifications not expressly approved by Rain Bird could void the user's authority to operate the equipment. Unapproved devices may damage the controller and void the warranty. For a list of compatible devices go to: www.rainbird.com

Changes or modifications not expressly approved by Rain Bird could void the user's authority to operate the equipment.

Date and time are retained by a lithium battery which must be disposed of in accordance with local regulations.

The Intelligent Use of Water®

LEADERSHIP · EDUCATION · PARTNERSHIPS · PRODUCTS

At Rain Bird, we believe it is our responsibility to develop products and technologies that use water efficiently. Our commitment also extends to education, training and services for our industry and community.

The need to conserve water has never been greater. We want to do even more and with your help we can. Visit www.rainbird.com for more information about The Intelligent Use of Water®.



Rain Bird Corporation
6991 East Southpoint Road
Tucson, AZ 85756
USA
Tel: (520) 741-6100

Rain Bird Corporation
970 West Sierra Madre Ave.
Azusa, CA 91702
USA
Tel: (626) 812-3400

Rain Bird International
1000 West Sierra Madre
Azusa, CA 91702
USA
Phone: (626) 963-9311

**Technical Services for
U.S. and Canada only:**
1 (800) RAINBIRD
1-800-247-3782
www.rainbird.com

**Specification Hotline
U.S. and Canada only:**
1 (800) 458-3005