

Junior DC

Installation instructions:

Mount the controller on the wall, using the wall mount bracket or on the valve, using the valve mounting bracket.

Connect the solenoid wires to the controller. Each cable coming out from the controller is marked with a station number. Connect RED from solenoid to RED from controller and the same for the BLACK wire.

Use the WaterProof Crimp Connectors to make the connections. Unused wires should be taped to prevent short circuit.

Connect the wires **FIRST** before installing the battery!

When battery is connected the controller checks the valves position to make sure they are closed!

9 volt Valve -

A 9 volt, pulse operated solenoid must be used with this controller. It is also referred to as: 9 volt latching solenoid. The solenoid could be 2-way or 3-way for hydraulic valve applications.

Note: Illustration represents 2 valve application.

Controller mounted on valve:

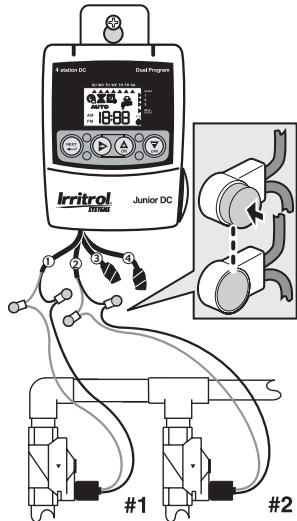
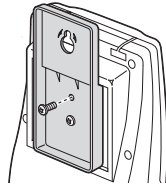
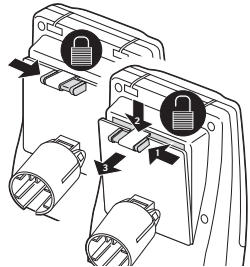
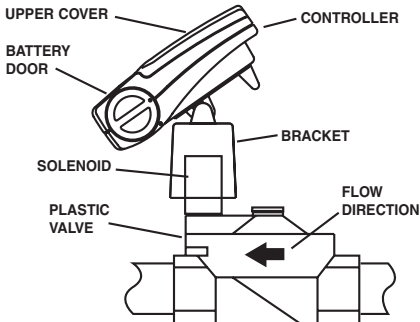

THE CONTROL PANEL:

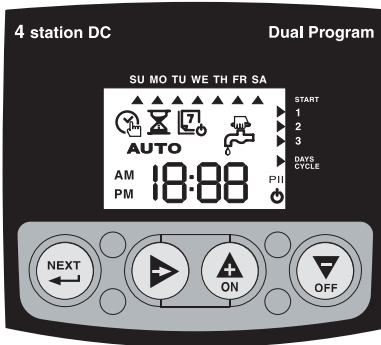

The control buttons:



"NEXT STEP"-Advance to next programming step.



Advance Days & Station number. In watering time position will lead you to % scaling.



Increase TIME & Watering Time. Used also as "ON" for Days ON and Manual ON.



Decrease TIME & Watering Time. Time. Used also as "OFF" for Days OFF & Manual OFF.

Battery connection

Please make sure that your 9 volt battery is an ALKALINE battery of good quality. Under normal use, the battery should last for one irrigation season.

Low battery indication will start flashing when battery is low. Replace battery.

Step 1:

Turn the battery door left about 45°.



Step 2:

Remove the battery door.



Step 3:

Insert a 9 volt **ALKALINE** battery with + facing the front panel.

Step 4:

Push the battery door back to it's position as shown in step 2. Turn clockwise to it's original position.

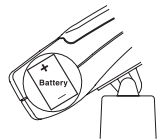

Display Icons:



Set current TIME & DAY



Watering duration time



Irrigation Days ON / OFF



Manual or Semi-Auto

AUTO Automatic operation

PI & PII Program 1 & Program 2



OFF - no watering



Station Number Icon



Low Battery (flashing)

Irrigation Program



Irrigation program consists of 3 parameters:

① Watering duration for each station ② Irrigation Days ③ Program Start Time

Each station can be assigned to a program by entering Water Time in that program.

Stations can be assigned to both programs.

PROGRAMMING STEPS

NOTE: If you press  or  continuously, the digits will advance quickly.



To Set the Current Day and Time.

After connecting the battery, the controller should display the "SET TIME/DAY" icon. If not, Press  until it is displayed.

Press  until arrow points to current day.



Press  or  to set current time.

Press  to enter watering time.

PI
PII  **1**

To Set the Length of Watering Time.

Enter Watering Time to all stations you wish to assign to this program. Each station can be programmed to have different Watering Time.

Press  or  to set the watering time

Press  to select your next station in this program. (JRDC-4)

Repeat for all the stations.

Press  to advance to next programming step.

PI
PII  **2**

Setting the Days of the Week.

OR

 DAYS CYCLE

To Set the Number of Days Between Watering.

You can either select the days of the week you wish to water or select days cycle. Arrow under SU is flashing.

Press  for the days you wish to water.

Press  for the days you wish to skip irrigation.

Press  until arrow points to days cycle.

Press  or  to select your days cycle.



Notice that two sets of digits are displayed (). The right digit will display the selected days cycle while the left digit will display the remaining days to irrigation. If 1 is selected = Every day. 2=Every other day. 3= once every 3 days and so on.

Press  if you wish to return to "days of the week"

Press  to program the start time.

PI
PII  **3**

To Set Watering Start Time(s).

Press  or  to set the time. (Notice the AM & PM)

Press  to set next (2nd) start time.

At the time you selected, the 1st station of Prog. 1 will start watering. Other stations in this program will operate sequentially, one after the other, automatically.

To enter program 2 (PII) Press  and repeat from **1** to **3**.

To skip program 2, Press  continuously until you reach  Manual .

IMPORTANT: A delay of 2-3 sec. between pressing ON or OFF to the actual response of the valve was design to save energy



To Water Manually.

NOTE!

To get to Manual mode from any position, press  continuously.

Two MANUAL modes are available:

Manual start per station (only that station)

Press  to open the station. (Station Icon will stop flashing)

Press  to turn off the station.

Press  to select your next station. (JRDC-4)

If you leave the station ON, it will close after its programmed watering time. First priority is watering time program 1, 2nd priority is watering time program 2, and if no watering time was programmed, will open for 2 minutes. After the station is closed, the controller will skip to AUTO mode.

Press  to select next manual mode.

Manual start per program - Semi-Auto

In this step, you can turn on all the stations programmed in program 1 or program 2. The valves will open in sequence.

The 1st programmed station in this program will flash.

Press  to start the cycle and  to terminate it.

Press  to select program 2. repeat as in prog.1

Press  to advance to AUTO mode. Will turn off all stations

AUTO



Will display Time & Day, open station, low battery and OFF.

Press  in AUTO mode to stop irrigation. (OFF is displayed)



Press  in AUTO mode to resume irrigation.



WATER BUDGET

PI & PII

When you wish to either increase or decrease watering time for all stations in a program, you can do it by using percentage scaling.



Your current setting of watering time represent 100%.

You can get to Water Budget position from any Watering Time  position. Press  until you pass all stations and display show 100 and the active stations in that program are flashing.







Press  to increase and  to decrease the percentage.

Press  to increase and  to decrease the percentage.

EX: If stations in PI are set at 10 minutes runtime and you increase percentage to 150%, they will run 15 minutes each. (The new 100%)

Press  to skip to MANUAL  mode.

IMPORTANT INFORMATION

- The  button leads you through the programming steps.
- Auto Return: If within 3 minutes you do not touch any button, the controller will automatically return to Auto mode except from MANUAL mode.
- Quick Digit advance: If you Press  or  continuously, the digits will advance quickly.
- Reset display back to OFF: If you press  and  simultaneously and hold for few seconds, the digits displayed will reset back to OFF.
- Program Erase: In Auto Run mode, press  and  simultaneously until arrow starts to flash. It will flash 5 times to complete Program Erase.

Irritrol
SYSTEMS

USA:(Tel) 1-909-785-3623 (Fax) 1-909-785-3795

Europe: (Tel) 00-39-765-4 5201 (Fax) 00-39-765-455386

Australia: (Tel) 08-8300-3633 (Fax) 08-8243-2940

© 2005 Irritrol Systems P/N 373-0218 Rev. B

Instrucciones para la instalación del programador Junior DC:

Monte el programador en la pared usando el soporte de montaje para la pared, o en la válvula usando el soporte de montaje para la válvula.

Conecte los cables del solenoide al programador. Cada cable que viene del programador está marcado con el número de una estación. Conecte el cable ROJO del solenoide al cable ROJO del programador y siga el mismo procedimiento con el cable NEGRO.

Use los Conectores Embutibles Impermeables provistos para efectuar las conexiones. Los cables que no se usen deberán cubrirse con cinta aislante para que no produzcan cortocircuitos.

¡Conecte los cables PRIMERO, antes de instalar la pila!

Al conectar la pila, el programador verificará la posición de las válvulas para asegurarse de que estén cerradas.

Válvula de 9 voltios

Con este programador debe usarse un solenoide de 9 voltios operado por impulsos. Este, también se conoce con el nombre de solenoide de enganche de 9 voltios. El solenoide puede ser de 2 vías o de 3 vías para aplicaciones de válvulas hidráulicas. Nota: La ilustración representa una aplicación de 2 vías.

Programador montado en la válvula

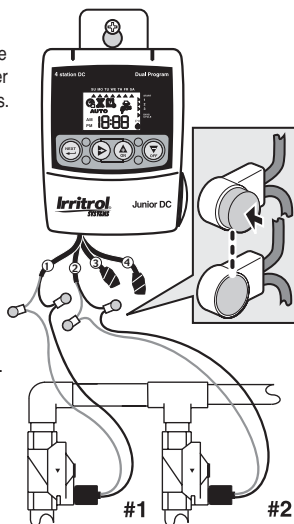
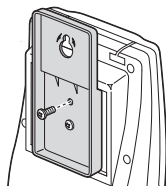
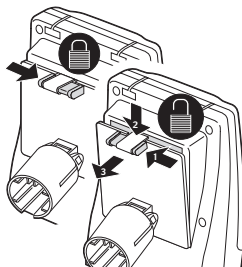
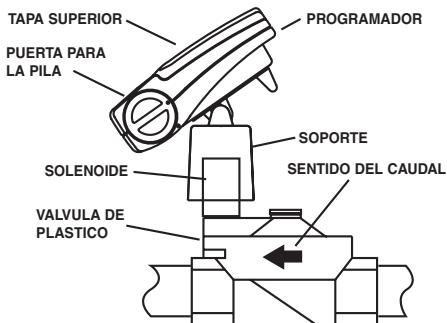

EL PANEL DE CONTROL:

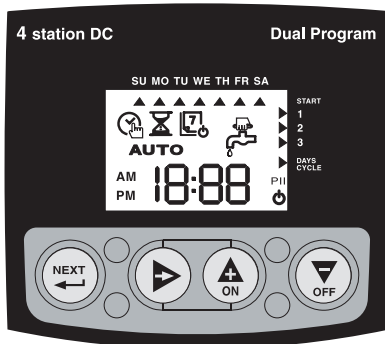

Los botones de control:



NEXT STEP (Paso Siguiente) - Avanzar hasta el paso siguiente de la programación).



Avanzar el número de Días y Estación. En la posición de Tiempo de Riego, este botón le llevará al ajuste del porcentaje de riego.

Conexión de la pila

Asegúrese de que la pila de 9 voltios sea una pila **ALCALINA** de buena calidad. En condiciones normales de uso, la pila suele durar una temporada de riego completa.

La indicación "**Carga Baja de la Pila**" comenzará a destellar cuando la pila tenga poca carga. Reemplace la pila.

Paso 1:

Dé vuelta a la puerta de compartimiento de la pila 45° para quitar.



Paso 2:

Abra la puerta de la pila.



Paso 3:

Introduzca una nueva pila **ALCALINA** de 9 voltios con el polo + mirando hacia el panel frontal.

Paso 4:

Cierre la puerta de la pila a la posición que se muestra en el Paso 2. Luego gire la puerta a su posición original.

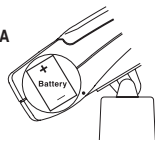

Iconos de la pantalla:



Establecer la **HORA** y el **DIA** actuales



Duración del tiempo de riego



Días de riego **ON** (Activados) / **OFF** (Desactivados)



Operación **Manual** o **Semiautomática**

AUTO

Operación automática

PI & PII

Programa 1 y Programa 2



OFF (Desactivado) - no hay riego



Icono del número de la estación



Carga baja de la pila (destellando)



Aumentar la **HORA** y el **Tiempo** de Riego. También se usa como "**ON**" (Activar) para los días **ON** (Activados) y **Manual ON** (Operación manual activada).



Reducir la **HORA** y el **Tiempo** de Riego. También se usa como "**OFF**" (Desactivar) para los días **OFF** (Desactivados) y **Manual OFF** (Operación manual desactivada).

Programa de riego

El programa de riego consta de 3 parámetros:

➊ Duración del riego para cada estación ➋ Días de riego ➌ Hora de arranque del programa
Cada estación puede asignarse a un programa ingresando el Tiempo de Riego en ese programa.
Las estaciones pueden asignarse a ambos programas.

PASOS PARA LA PROGRAMACION

NOTA: Si oprime el botón  o el botón  continuamente, los dígitos avanzarán rápidamente.



Para establecer el Día y la Hora Actuales

Después de conectar la pila, deberá aparecer en la pantalla del programador el icono "Establecer la HORA y el DIA actuales". De lo contrario, oprima el botón  hasta que aparezca el mismo.

Oprima  hasta que la flecha apunte hacia el día actual.

Oprima  o  para establecer la hora actual.

Oprima  para ingresar el tiempo de riego.

Ingrese el Tiempo de Riego en todas las estaciones que desee asignar a este programa. Cada estación puede programarse para que tenga un Tiempo de Riego diferente.

Oprima  o  para establecer el tiempo de riego.

Oprima  para seleccionar la estación siguiente en este programa. (JRDC-4)

Repita este procedimiento para todas las estaciones del programa.

Oprima  para avanzar al paso siguiente de la programación.

Puede seleccionar los días de la semana en que desee regar o bien el ciclo de días. La flecha bajo SU está destellando.

Oprima  para establecer los días en que desea regar.

Oprima  para establecer los días en que desea omitir el riego.

Oprima  hasta que la flecha apunte hacia el ciclo de días.

Oprima  o  para seleccionar el ciclo de días.

Observe que aparecen en la pantalla dos conjuntos de dígitos **{ 0 0 }**. El dígito de la derecha indica el ciclo de días seleccionado y el dígito de la izquierda indica los días que faltan para el riego.

Si se selecciona 1 = Cada día. 2 = Cada segundo día. 3 = Cada tercer día, etc.

Oprima  si desea regresar a "los días de la semana".

Oprima  para programar la hora de arranque.

Oprima  o  para establecer la hora. (Observe las indicaciones AM y PM).

Oprima  para establecer la siguiente (2da) hora de arranque.



Para establecer la Duración del Tiempo de Riego



Para establecer los Días de la Semana

DAYS CYCLE

Para establecer el Número de Días entre Riegos



Para establecer la(s) hora(s) de arranque

A la hora que haya seleccionado, la 1ra estación del Programa 1 iniciará el riego. Las demás estaciones de este programa operarán secuencialmente, una tras otra, automáticamente.

Para ingresar el programa 2 (PII), oprima  y repita del **1** al **3**.

Para omitir el programa 2, oprima  continuamente hasta que aparezca  Operación Manual.

IMPORTANTE: La demora de 2 a 3 segundos que se produce desde el momento en que se oprime el botón ON u OFF hasta el momento en que se produce la respuesta de la válvula fue diseñada especialmente para ahorrar energía.



Hay disponibles dos modos MANUALES:
Arranque Manual por estación (solamente esa estación)

Oprima para activar la estación. (EL icono de la estación dejará de destellar).

Oprima para desactivar la estación.

Oprima para seleccionar la estación siguiente. (JRDC-4)

Para regar manualmente

NOTA!

Para pasar al modo Manual desde cualquier posición, oprima continuamente.

Si deja la estación ON (Activada), ésta se desactivará al terminar su tiempo de riego programado. La 1ra prioridad es el tiempo de riego del programa 1; la 2da prioridad es el tiempo de riego del programa 2. Si no se ha programado ningún tiempo de riego, la estación se activará durante 2 minutos solamente. Después de que la estación se ha desactivado, el programador pasará al modo AUTO.

Oprima para seleccionar el modo manual siguiente.

Arranque Manual por programa - Semiauto

En este paso, usted puede activar todas las estaciones programadas en el programa 1 o en el programa 2. Las válvulas se abrirán en secuencia.

La 1ra estación programada en este programa destellará.

Oprima para iniciar el ciclo y para terminarlo.

Oprima para seleccionar el programa 2; repita el mismo procedimiento que en el programa 1.

Oprima para avanzar al modo AUTO. Se desactivarán todas las estaciones.

Aparecerán en pantalla las indicaciones de Hora y Día, Estación activada, Carga baja de la pila y OFF.

Oprima en el modo AUTO para detener el riego. (Aparecerá OFF).

Oprima en el modo AUTO para reanudar el riego.

Cuando desee aumentar o reducir el tiempo de riego en todas las estaciones de un programa, podrá hacerlo usando el ajuste del porcentaje de riego.

El ajuste actual del tiempo de riego representa un porcentaje del 100%.

Puede pasar a la posición de ajuste del Porcentaje de Riego desde la posición de cualquier Tiempo de Riego . Oprima hasta que pasen todas las estaciones y aparezca en la pantalla y las estaciones activas del programa estén destellando.

Oprima para aumentar o para reducir el porcentaje de riego.

EJEMPLO: Si se ha establecido un tiempo de riego de 10 minutos para las estaciones del PI y se aumenta el porcentaje de riego a 150%, el tiempo de riego de cada una de estas estaciones será de 15 minutos. (El nuevo porcentaje de 100%).

Oprima para pasar al modo MANUAL .

AUTO



WATER BUDGET
(Porcentaje de riego)
PI y PII

INFORMACION IMPORTANTE

- El botón lo conducirá a través de los pasos de programación.
- Regreso automático: Si no se oprime ningún botón dentro de 3 minutos, el programador regresará automáticamente al modo AUTO, excepto si está en el modo MANUAL.
- Avance rápido de los dígitos: Si se oprime o continuamente, los dígitos avanzarán rápidamente.
- Reposición de los dígitos a OFF: Si se oprimen los botones y simultáneamente y se mantienen oprimidos durante unos segundos, los dígitos de la pantalla se repositionarán a OFF.
- Borrado del programa: En el modo Auto Run (Operación automática), oprima los botones y simultáneamente hasta que la flecha comience a destellar. Destellará 5 veces para completar el borrado del programa.

EE.UU.: (Tel.) 1-909-785-3623; (Fax) 1-909-785-3795

Europa: (Tel.) 00-39-765-455201; (Fax) 00-39-765-455386

Australia: (Tel.) 08-8300-3633; (Fax) 08-8243-2940

© 2005 Irritrol Systems P/N 373-0218 Rev. B

Irritrol
SYSTEMS

Junior DC

Consignes d'installation :

Montez le programmeur sur un mur à l'aide du support de montage mural ou sur la vanne au moyen du support de montage prévu à cet effet.

Branchez les fils de l'électrovanne au programmeur. Chaque câble sortant du programmeur porte un numéro de voie.

Connectez respectivement le fil ROUGE et le fil NOIR de l'électrovanne au fil ROUGE et au fil NOIR du programmeur. Réalisez les branchements à l'aide des connecteurs sertissants étanches. Posez du ruban adhésif sur les fils inutilisés afin d'éviter les court-circuits.

Branchez les fils AVANT de poser la pile !

Quand la pile est connectée, le programmeur vérifie la position des vannes afin de s'assurer qu'elles sont fermées !

Vanne 9 volts

Un solénoïde 9 volts à fonctionnement par impulsions, également appelé solénoïde 9 volts à verrouillage, doit être employé avec ce programmeur. Il doit s'agir d'un solénoïde à 2 ou 3 voies pour électrovannes hydrauliques.

Remarque : l'illustration représente une application à 2 vannes.

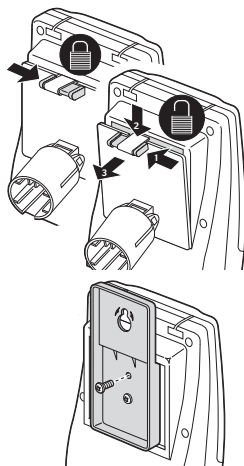

Programmeur monté sur vanne

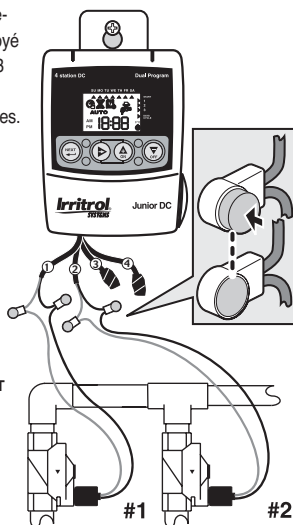
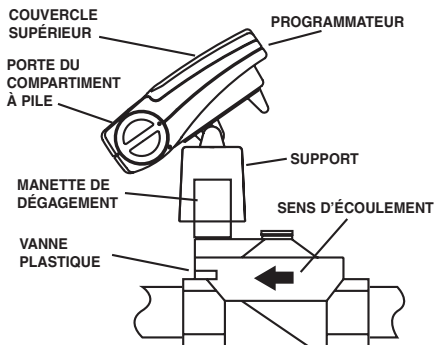

LE PANNEAU DE COMMANDE :

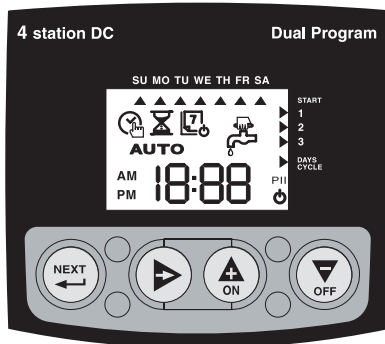

Les boutons de commande :



ÉTAPE SUIVANTE - Fait passer à l'étape suivante de la programmation.



Fait avancer les jours et les numéros de voie. À la position de durée d'arrosage, fait passer à l'ajustement en pourcentage.



Sert à avancer l'heure (TIME) et à augmenter la durée d'arrosage. Également utilisé comme bouton d'activation (ON) des jours et du mode Manuel.



Sert à reculer l'heure (TIME) et à réduire la durée d'arrosage. Également utilisé comme bouton de désactivation (OFF) des jours et du mode Manuel.

Branchement de la pile

Veillez à utiliser une pile 9 V ALCALINE de bonne qualité. Dans des conditions d'utilisation normales, la pile devrait durer une saison d'arrosage.

Remplacez la pile lorsque l'indicateur de pile faible se met à clignoter.

Étape 1 :

Tournez la porte du compartiment à pile d'environ 45 degrés.



Étape 2 :

Retirez la porte.



Étape 3 :

Insérez une pile 9 V ALCALINE en orientant le côté positif (+) vers le panneau avant.

Étape 4 :

Pressez la porte du compartiment à sa position indiquée à l'étape 2 et tournez-la dans le sens jusqu'à sa position initiale.

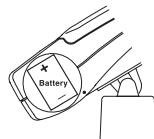

Programme d'arrosage

Le programme d'arrosage se compose de 3 paramètres :

① Durée d'arrosage de chaque voie ② Jours d'arrosage ③ Heure de démarrage du programme
Chaque voie peut être affectée à un programme en entrant une durée d'arrosage dans ce programme.
Il est possible d'affecter les voies aux deux programmes.

Icônes de l'affichage :



Réglage de l'HEURE et du JOUR courants



Durée d'arrosage



Jours d'arrosage ACTIVÉS / DÉSACTIVÉS



Mode Manuel ou Semi-automatique

AUTO

Fonctionnement automatique

PI & PII

Programme 1 et programme 2



DÉSACTIVÉ - pas d'arrosage



Icône de numéro de voie



Batterie faible (clignotant)

ÉTAPES DE LA PROGRAMMATION

REMARQUE : Si vous appuyez de manière continue sur  ou , les chiffres défilent rapidement.



Réglage du jour et de l'heure courants.



Réglage de la durée d'arrosage.



Sélection des jours de la semaine.

OU



Réglage de l'interval-
le entre jours
d'arrosage.



Réglage de la ou des heures de démarrage de l'arrosage.

Une fois la pile branchée, le programmeur devrait afficher l'icône de réglage de l'heure et du jour (SET TIME/DAY). Dans la négative, appuyez sur  jusqu'à ce que cette icône apparaisse.

Appuyez sur  jusqu'à ce que la flèche indique le jour courant.

Appuyez sur  ou  pour régler l'heure courante.

Appuyez sur  pour régler la durée d'arrosage.

Entrez une durée d'arrosage pour toutes les voies que vous désirez affecter à ce programme. Il est possible de programmer une durée d'arrosage différente pour chaque voie.

Appuyez sur  ou  pour régler la durée d'arrosage.

Appuyez sur  pour sélectionner la voie suivante de ce programme. (JRDC-4)

Répétez cette procédure pour toutes les voies.



Appuyez sur  pour passer à l'étape suivante de la programmation.

Vous pouvez soit sélectionner les jours de la semaine auxquels vous désirez arroser, soit sélectionner un cycle d'arrosage en jours. La flèche au-dessous de SU clignote.

Appuyez sur  pour activer les jours d'arrosage.

Appuyez sur  pour désactiver les jours d'arrosage.

Appuyez sur  jusqu'à ce que la flèche indique Cycle.

Appuyez sur  ou  pour sélectionner le cycle en jours.

Vous pouvez remarquer que deux valeurs numériques sont affichées (0 0).

Celle de droite indique le cycle sélectionné tandis que celle de gauche indique les jours restants jusqu'à l'arrosage.

1 = tous les jours 2 = 1 jour sur 2 3 = tous les 3 jours, et ainsi de suite.

Appuyez sur  si vous désirez retourner aux jours de la semaine.



Appuyez sur  pour programmer l'heure de démarrage.

Appuyez sur  ou  pour régler l'heure (prêtez attention à l'indication AM ou PM).

Appuyez sur  pour régler l'autre (2e) heure de démarrage.

À l'heure choisie, la première voie du programme 1 commence à arroser. Les autres voies de ce programme démarrent automatiquement en ordre successif.

Pour passer au programme 2 (PII), appuyez sur  et répétez les étapes **1** à **3**.

Pour sauter le programme 2, appuyez de manière continue sur  jusqu'à arriver au symbole .

IMPORTANT : Un délai de 2 à 3 secondes, destiné à économiser l'énergie, sépare le moment où vous appuyez sur ON ou OFF du moment où la vanne réagit.



Arrosage manuel

REMARQUE!

Pour passer au mode Manuel à partir de toute position, appuyez de manière continue sur .

AUTO



WATER BUDGET (BUDGET EAU) Pi et PII

Deux modes manuels sont disponibles :

Démarrage manuel par voie (cette voie seulement)

Appuyez sur  pour ouvrir la voie (l'icône de la voie cesse de clignoter).

Appuyez sur  pour fermer la voie.

Appuyez sur  pour sélectionner la voie suivante. (JRDC-4)

Si vous laissez la voie ouverte (ON), elle se ferme à la fin de sa durée d'arrosage programmée. La durée d'arrosage du programme 1 a priorité sur celle du programme 2.



Si aucune durée d'arrosage n'a été programmée, la voie arrose pendant 2 minutes.

Une fois la voie fermée, le programmeur passe en mode AUTO.

Appuyez sur  pour sélectionner l'autre mode manuel.

Démarrage manuel par programme - Semi-automatique

Dans ce mode, vous pouvez activer toutes les voies affectées au programme 1 ou au programme 2. Les vannes s'ouvrent en séquence. Le première voie programmée dans ce programme se met à clignoter.

Appuyez sur  pour lancer le cycle et sur  pour y mettre fin.

Appuyez sur  pour sélectionner le programme 2 et procédez comme pour le programme 1.





Appuyez sur  pour passer au mode AUTO. Toutes les voies sont alors désactivées.

Indique heure et jour, voie ouverte, pile faible et désactivation (OFF).

Appuyez sur  en mode AUTO pour arrêter l'arrosage (l'affichage indique OFF).

Appuyez sur  en mode AUTO pour reprendre l'arrosage.







Lorsque vous souhaitez augmenter ou réduire la durée d'arrosage pour toutes les voies d'un programme, vous pouvez utiliser l'ajustement en pourcentage. La durée d'arrosage actuellement réglée représente 100 %.

Vous pouvez passer à la position Water Budget (Budget eau) à partir de toute position Time Watering  (Durée d'arrosage). Appuyez sur  pour faire défiler toutes les voies jusqu'à ce que l'écran indique *100* et que les voies actives de ce programme clignotent. Appuyez sur  pour augmenter le pourcentage et sur  pour le réduire.

Exemple : Si toutes les voies du programmes 1 sont réglées pour arroser pendant 10 minutes et que vous augmentez le pourcentage jusqu'à 150 %, elles arroseront pendant 15 minutes (cette durée représente maintenant 100 %).

Appuyez sur  pour passer au mode MANUAL .

INFORMATIONS IMPORTANTES

- Le bouton  vous permet de parcourir les étapes de la programmation.
- Rétablissement automatique : Si vous ne touchez aucun bouton pendant 3 minutes, le programmeur repasse automatiquement en mode Auto, sauf à partir du mode Manuel.
- Défilement rapide des chiffres : Si vous appuyez de manière continue sur  ou , les chiffres défileront rapidement.
- Réinitialisation de l'affichage à OFF : Si vous appuyez simultanément sur  et  pendant plusieurs secondes, l'affichage des valeurs numériques est réinitialisé à OFF.
- Effacement de programme : En mode Auto Run, appuyez simultanément sur  et  jusqu'à ce que la flèche clignote. Après 5 clignotements, le programme est totalement effacé.

Irritrol
SYSTEMS

États-Unis : (Tél.) 1-909-785-3623 (Fax) 1-909-785-3795

Europe : (Tél.) 00-39-765-455201 (Fax) 00-39-765-455386

Australie : (Tél.) 08-8300-3633 (Fax) 08-8243-2940

© 2005 Irritrol Systems P/N 373-0218 Rev. B

Junior DC Installationsanleitung:

Befestigen Sie die Steuerung mit der Halterung für die Wandmontage an der Wand oder mit der Halterung für die Ventilmontage am Ventil.

Schließen Sie die Magnetventil-Leitungen an die Steuerung an.

Alle von der Steuerung abgehenden Kabel sind mit einer Stationsnummer gekennzeichnet. Verbinden Sie die ROTE Leitung des Magnetventils mit dem ROTEN Kabel der Steuerung und verfahren Sie ebenso mit den SCHWARZEN Kabeln.

Verwenden Sie die wasserdichten Crimp-Verbinder für die Anschlüsse. Schützen Sie zur Verhinderung von Kurzschlüssen die nicht genutzten Zuleitungen mit Isolierband.

Stellen Sie diese Verbindungen her, BEVOR Sie die Batterie installieren!

Nach Anschluss der Batterie prüft die Steuerung, ob sich die Ventile in geschlossener Stellung befinden.

9-Volt-Ventil

Mit dieser Steuerung muss ein impulsgesteuertes Magnetventil (9 V) verwendet werden. Es wird auch als "Stromstoß"-Ventil bezeichnet. Bei diesem Ventil kann es sich um ein Zwei- oder Drei-Wege-Ventil für Hydraulikventilanwendungen handeln.

Hinweis: Die Darstellung zeigt ein Zwei-Wege-Ventil.

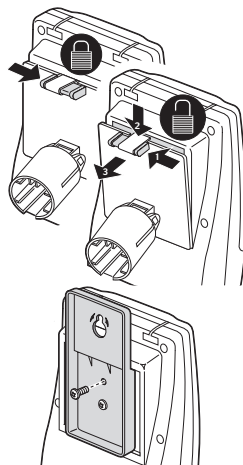



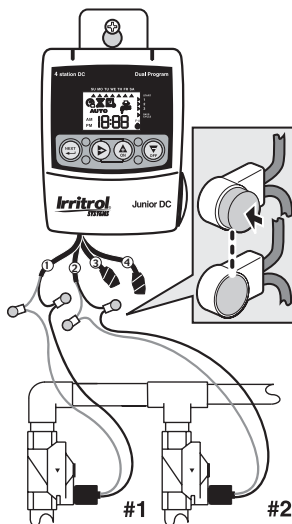
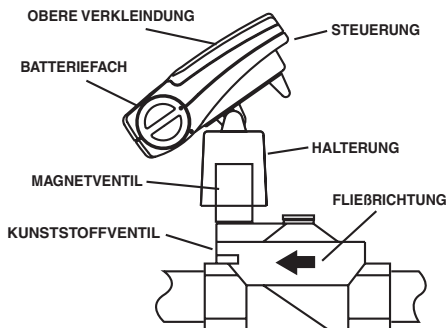

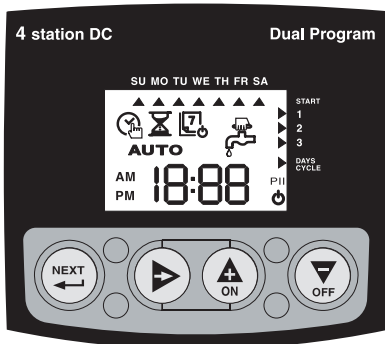

Ventilmontage der Steuerung





DAS BEDIENFELD:





Anzeigesymbole:

-  Aktuelles Datum/Uhrzeit einstellen
-  Bewässerungszeit
-  Bewässerungstage EIN/AUS
-  Manuell oder Halbautomatisch
- AUTO** Automatikbetrieb
- PI & PII** Programm 1 & Programm 2
-  AUS - Keine Bewässerung
-  Stationsnummer-Symbol
-  Batterie entladen (blinkt)

Bedientasten:

-  "Weiter" - Springt zum nächsten Programmierschritt.
-  Vorlaufstage und Stationsnummer. In der Stellung "Bewässerungszeit" wird hier eine Prozentskala angezeigt.

-  UHRZEIT und Bewässerungszeit erhöhen. Dient auch zum Einschalten für "Tage EIN" und "Manuell EIN".
-  UHRZEIT und Bewässerungszeit verringern. Dient auch zum Ausschalten für "Tage AUS" und "Manuell AUS".

Batterie einsetzen

Bitte setzen Sie nur eine 9-V-ALKALI-Batterie von guter Qualität ein. Bei Normalbetrieb hält diese Batterie eine Bewässerungssaison lang.

Die **Batterieanzeige** beginnt zu blinken, wenn die Batterie fast entladen ist. Wechseln Sie die Batterie aus.

Schritt 1:

Drehen Sie die Batteriefachkappe nach links um 45°.



Schritt 3:

Setzen Sie eine 9-V-ALKALI-Batterie mit zur Frontplatte weisendem Pluspol ein.

Schritt 4:

Drücken Sie die Batteriefachkappe zurück in die in Schritt 2 dargestellte Position. Drehen Sie sie die Ausgangsstellung zurück.

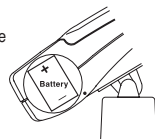

Schritt 2:

Ziehen Sie die Batteriefachkappe ab.



Bewässerungsprogramm

Das Bewässerungsprogramm setzt sich aus 3 Parametern zusammen:

- ➊ Bewässerungszeit für die einzelnen Stationen
 - ➋ Bewässerungstage
 - ➌ Programmstartzeit
- Durch Eingabe der Wasserzeit in das jeweilige Programm werden die einzelnen Stationen einem Programm zugewiesen. Stationen können beiden Programmen zugewiesen werden.

PROGRAMMIERSCHRITTE

Hinweis: Wenn Sie  oder  gedrückt halten, laufen die Ziffern schneller durch.



Einstellen von
Datum/Uhrzeit

Nach dem Einsetzen der Batterie muss die Steuerung wieder das Symbol DATUM/UHRZEIT EINSTELLEN anzeigen. Ansonsten drücken Sie "Weiter", bis das Symbol  angezeigt wird.

Drücken Sie  , bis der Pfeil auf das aktuelle Datum weist.

Drücken Sie  oder  zum Einstellen der Uhrzeit.

Drücken Sie "Weiter"  zur Eingabe der Bewässerungszeit.

Geben Sie für alle Stationen, denen Sie ein Programm zuweisen möchten, eine Bewässerungszeit ein. Für jede Station kann dabei eine andere Bewässerungszeit eingegeben werden.

Drücken Sie  oder  zum Einstellen der Bewässerungszeit.

Drücken Sie  zur Anwahl der nächsten Station in diesem Programm. (JRDC-4)

Wiederholen Sie diese Schritte für alle Stationen.

Drücken Sie "Weiter"  , um zum nächsten Programmschritt zu gelangen.

Sie können entweder Wochentage zum Bewässern oder einen Tageszyklus auswählen. Der Pfeil unter SU blinkt.

Drücken Sie  für die Tage, an denen Sie bewässern möchten.

Drücken Sie  für die Tage, an denen keine Bewässerung erfolgen soll.

Drücken Sie  , bis der Pfeil auf "Tageszyklus" weist.

Drücken Sie  oder  zur Auswahl Ihres Tageszyklus.

Es werden zwei Stellen () angezeigt. Die rechte Stelle zeigt den gewählten Tageszyklus an, während die linke Stelle die verbleibenden Tage bis zur nächsten Bewässerung anzeigt.

1 = täglich 2 = jeden 2. Tag 3 = alle drei Tage usw.

Drücken Sie  , um zu "Wochentage" zurückzukehren.

Drücken Sie "Weiter"  , um die Programmstartzeit einzustellen.

Drücken Sie  oder  zum Einstellen der Uhrzeit (vormittags/nachmittags beachten).

Drücken Sie "Weiter"  , um die nächste (zweite) Startzeit einzustellen.



Einstellen der
Wochentage

ODER
 DAYS
CYCLE



Einstellen der
Anzahl von Tagen
zwischen
Bewässerungen



Einstellen der
Bewässerungszeit(en)

Zur gewählten Uhrzeit beginnt die 1. Station von Programm 1 mit der Bewässerung. Andere Stationen in diesem Programm werden automatisch nacheinander angesteuert.

Drücken Sie zur Eingabe von Programm 2 (PII) "Weiter"  und wiederholen Sie die Schritte **1** bis **3** .

Drücken Sie zum Überspringen von Programm 2 so lange "Weiter"  , bis die Einstellung "Manuell"  erreicht ist.

WICHTIGER HINWEIS: Eine Verzögerung von 2-3 Sekunden zwischen dem Drücken von ON oder OFF und dem Ansprechen des Ventils ist konstruktionsbedingt und dient der Energieeinsparung.



So bewässern

Sie manuell

HINWEIS!

Um von einer beliebigen Stellung auf "Manuell" zu schalten, halten Sie einfach die "Weiter"  Taste gedrückt.

AUTO



WATER BUDGET (WASSERHAUSHALT) PI & PII

Es stehen zwei manuelle Betriebsarten zur Verfügung:

Manueller Start pro Station (nur für die jeweilige Station)

Drücken Sie  zum Öffnen der Station (Stationssymbol hört auf zu blinken).

Drücken Sie  zum Abstellen der Station.

Drücken Sie  zum Wählen der nächsten Station. (JRDC-4)

Wenn Sie die Station auf ON lassen, schließt sich diese nach der programmierten Bewässerungsdauer. Die Zeit von Bewässerungsprogramm 1 hat Vorrang, Bewässerungsprogramm 2 folgt. Wenn keine Bewässerungszeit programmiert wurde, beträgt die Öffnungsdauer zwei Minuten. Nach dem Schließen der Station schaltet die Steuerung in die Betriebsart AUTO zurück.

Drücken Sie "Weiter" , um die nächste manuelle Betriebsart auszuwählen.

Manueller Start pro Programm – Halbautomatisch

Bei diesem Schritt können Sie alle in Programm 1 oder Programm 2 programmierten Stationen einschalten. Die Ventile öffnen nacheinander. Die erste in diesem Programm programmierte Station blinkt.

Drücken Sie  zum Starten und  zum Beenden des Zyklus.

Drücken Sie "Weiter"  zur Auswahl von Programm 2, wiederholen Sie die Schritte von Programm 1.



Drücken Sie "Weiter"  um auf Automatik zu schalten. Dadurch werden alle Stationen geschlossen.

Anzeige: Datum/Uhrzeit, geöffnete Station, Batterie entladen und AUS.

Drücken Sie  im Automatikbetrieb zum Abschalten der Bewässerung. (AUS wird angezeigt).

Drücken Sie  im Automatikbetrieb zum Wiedereinschalten der Bewässerung.

Wenn Sie in einem Programm die Bewässerungszeit für alle Stationen erhöhen oder verringern möchten, lässt sich dies mit einer Prozentskala einstellen.







Die aktuelle Einstellung Ihrer Bewässerungszeit gilt dabei als 100 %. Sie können von einer beliebigen Bewässerungszeit-Position  zur Wasserhaushalt-Einstellung wechseln. Drücken Sie , bis alle Stationen passiert wurden und das Display  anzeigt, wobei die aktiven Stationen im Programm blinken.

Drücken Sie  zum Erhöhen und  zum Verringern des Prozentwerts.

BEISPIEL: Wenn die Stationen in Programm 1 eine Betriebsdauer von 10 Minuten haben und Sie den Prozentwert auf 150 erhöhen, bleiben diese 15 Minuten in Betrieb (nunmehr der neue 100%-Wert).

Drücken Sie "Weiter" , um zur Betriebsart "Manuell"  zu wechseln.

WICHTIGE HINWEISE

- Die Schaltfläche "Weiter"  führt Sie durch die Programmierschritte.
- Automatische Rücksetzung: Wenn Sie innerhalb von drei Minuten keine Taste berühren, schaltet die Steuerung außer in der Betriebsart "Manuell" stets zur Automatik zurück.
- Schnelldurchlauf der Ziffern: Halten Sie  oder  gedrückt, damit die Ziffern schneller durchlaufen.
- Display auf AUS zurücksetzen: Wenn Sie gleichzeitig  und  drücken und ein paar Sekunden gedrückt halten, werden die angezeigten Ziffern auf AUS zurückgesetzt.
- Programm löschen: Drücken Sie im Automatikbetrieb gleichzeitig auf  und , bis der Pfeil zu blinken beginnt. Er blinkt fünfmal, bis das Löschen des Programms abgeschlossen ist.

Irritrol
SYSTEMS

USA: (Tel.) 1-909-785-3623 (Fax) 1-909-785-3795

Europa: (Tel.) 00-39-765-455201 (Fax) 00-39-765-455386

Australien: (Tel.) 08-8300-3633 (Fax) 08-8243-2940

© 2005 Irritrol Systems P/N 373-0218 Rev. B

Junior DC

Istruzioni per installazione:

Montare il programmatore sulla parete sulla valvola, usando le rispettive apposite fasce di montaggio. Collegare i fili del solenoide al programmatore. Ogni cavo uscente dal programmatore è marcato con un numero di stazione. Collegare il ROSSO del solenoide al ROSSO del programmatore, e lo stesso per i fili NERI. Usare il connettore stagno per fare il collegamento. I fili inutilizzati dovrebbero essere avvolti per prevenire corti circuiti.

Collegare i fili PRIMA di installare la batteria!

Quando la batteria è collegata il programmatore verifica la posizione delle valvole per accertarsi che siano chiuse.

Valvola a 9 volt

Un solenoide ad impulso, a 9 volt, deve essere usato con questo programmatore: lo stesso vale per un solenoide latching a 9 volt. Il solenoide può essere a due vie o tre vie, per l'applicazione delle valvole idrauliche. Nota: l'illustrazione rappresenta l'applicazione di due valvole.

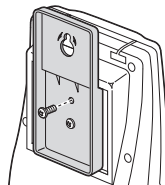
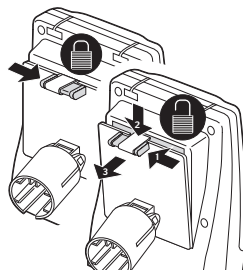

Programmatore montato su valvola

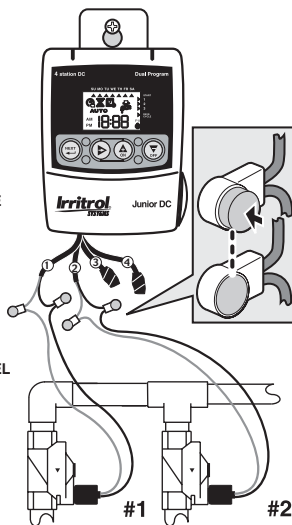
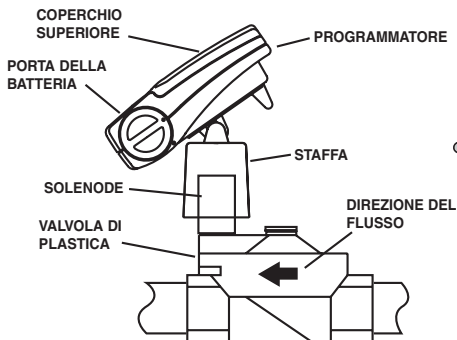

PANNELLO DI CONTROLLO: Icone display:

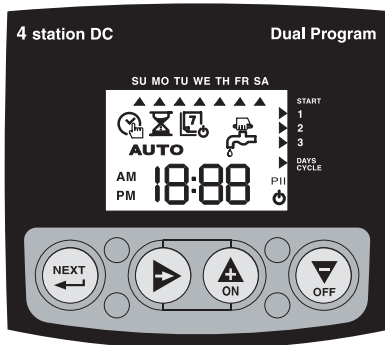

Impostazione ORARIO e GIORNO correnti

Tempo di durata di irrigazione

Giorni per irrigazione ON/OFF

Manuale o semi-automatico

AUTO operazione automatica

PI & PII programma 1 e programma 2

OFF – no irrigazione

Icona del numero di stazione

Esaurimento batteria (lampeggio)

Tasti di controllo:

"FASE SUCCESSIVA" – procedi alla prossima fase della programmazione

Aumenta il numero dei giorni e delle stazioni. In posizione "Watering Time", (durata dell'irrigazione) vi porterà alla scala di variazione della percentuale.

Aumento tempo & Durata di irrigazione. Usato anche come ON per Days ON e Manual ON.

Diminuzione tempo & Durata di erogazione. Tempo. Usato anche come OFF per Days OFF & Manual OFF.

Collegamento Batteria

Prego assicurarsi che la vostra batteria a 9 volt sia una batteria ALCALINA di buona qualità. Con un uso normale dovrebbe durare per una stagione d'irrigazione.

Il segnale di esaurimento batteria, comincerà a lampeggiare quando la batteria è alla minima carica. Sostituire la batteria.

Fase 1

Ruotare il coperchio della batteria circa 45°.



Fase 3

Inserire una batteria ALCALINA a 9 volt. Il polo positivo va posizionato in direzione del pannello frontale.

Fase 4

Premere il coperchio della batteria, fino alla sua posizione originale.

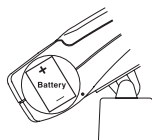

Fase 2

Estrarre il coperchio della batteria.



Programma d'irrigazione

Il programma di irrigazione è formato da 3 parametri:

① Durata di erogazione per ogni stazione ② Giorni per irrigazione ③ Tempo di partenza del Programma, inserendo il tempo di erogazione in quel Programma.

Ogni stazione può essere assegnata ad un programma. Le stazioni possono essere assegnate ad entrambi i programmi.

FASI DI PROGRAMMAZIONE

NOTA: Se tenete premuto Δ o ∇ , la cifra avanzerà rapidamente.



Per impostare il giorno e l'ora correnti.



Per impostare la durata di erogazione.



Impostazione dei giorni della settimana.

O

► DAYS
CYCLE

Per impostare il numero di giorni tra irrigazioni.



Per impostare il tempo o tempi di avvio.

Dopo aver collegato la batteria, il programmatore dovrebbe mostrare l'icona "SET TIME/DAY". In caso contrario, digitare \leftarrow (NEXT) finché apparirà sul display.

Premere \triangleright portando la punta della freccia fino al giorno corrente.

Premere Δ o ∇ per impostare l'ora esatta.

Premere \leftarrow (NEXT) per impostare la durata dell'erogazione.

Inserire la durata dell'erogazione (Watering Time) in ogni stazione che volete assegnare a questo programma. Ogni stazione può essere programmata per avere diverse durate di irrigazione.

Premere Δ o ∇ per impostare il tempo di irrigazione.

Premere \triangleright per selezionare la vostra prossima stazione in questo programma. (JRDC-4)

Ripetere ad ogni stazione

Premere \leftarrow (NEXT) per passare alla prossima fase di programmazione.

Potete selezionare o i giorni della settimana in cui volete irrigare, o selezionare un ciclo irriguo. La freccia sotto SU lampeggia.

Premere Δ per i giorni che volete irrigare.

Premere ∇ per i giorni in cui volete saltare l'irrigazione.

Premere \triangleright fino a portare la freccia al ciclo irriguo.

Premere Δ o ∇ per selezionare il vostro ciclo irriguo.

Attenzione, su display appaiono due cifre $\{ \text{ } \}$. La cifra di destra mostrerà il ciclo di giorni selezionato mentre quella di sinistra i giorni rimanenti per l'irrigazione. Se viene selezionato 1: ogni giorno 2: a giorni alterni 3: una volta ogni 3 giorni e così via.

Premere \triangleright se volete tornare ai "giorni della settimana".

Premere \leftarrow (NEXT) per programmare l'ora di inizio.

Premere Δ o ∇ per impostare l'ora. (attenzione a AM e PM).

Premere \leftarrow (NEXT) per impostare la prossima (seconda) ora di inizio.

Al tempo da voi selezionato, la prima stazione del programma 1 darà il via all'irrigazione. Le altre stazioni in questo programma funzioneranno in modo sequenziale, una dopo l'altra, automaticamente.

Per impostare il Programma 2 (PII), premere \leftarrow (NEXT) e ripetere da **1** a **3**.

Per saltare il Programma 2, premere \leftarrow (NEXT) continuamente fino a raggiungere manuale.

IMPORTANTE: Un ritardo di 2-3 secondi tra la pressione di ON o OFF e l'attuale risposta della valvola, ha lo scopo di risparmiare energia.



MANUALE

Per irrigare manualmente.

NOTA!

Per passare alla modalità Manuale da un'altra posizione qualsiasi, premere di continuo .

AUTO



WATER BUDGET PI & PII

Sono disponibili due modalità MANUALI:

Avvio manuale per stazione (solo quella stazione)

Premere  per aprire la stazione. (l'icona della stazione smetterà di lampeggiare).

Premere  per spegnere la stazione.

Premere  per selezionare la prossima stazione. (JRDC-4)

Se lasciate la stazione in posizione ON, sarà chiusa dopo la sua programmazione di irrigazione. La precedenza va al tempo di irrigazione del Programma 1, poi al tempo di irrigazione del programma 2 e, se nessun tempo di irrigazione è stato programmato, rimarrà aperto per due minuti. Dopo che la stazione sarà chiusa, il programmatore passerà alla modalità AUTO.

Premere  per selezionare il prossimo modo manuale.

Avvio manuale per programma – Semi-Auto

In questa fase potete accendere tutte le stazioni programmate in Programma 1 o Programma 2. Le valvole saranno aperte in sequenza.

La prima stazione programmata in questo Programma, lampeggerà.

Premere  per avviare il ciclo, e  per terminarlo.

Premere  per selezionare il Programma 2. Ripetere come nel Progr. 1.



Premere  per passare a modalità AUTO. Tutte le stazioni saranno chiuse.

Mostrerà ora (time) e giorno (day), stazione aperta, batteria scarica e OFF.

Premere  in modo AUTO per fermare l'irrigazione. (OFF sul display).

Premere  in modo AUTO per riprendere l'irrigazione.

Quando volete aumentare o diminuire il tempo di irrigazione per tutte le stazioni in un programma, potete farlo usando la scala di variazione percentuale. La vostra attuale impostazione di tempo di irrigazione, corrisponde al 100%.







Potete andare alla posizione Water Budget, da qualsiasi posizione di Tempo di Irrigazione . Premete  fino a passare tutte le stazioni e il display mostra  e le stazioni attive in quel programma lampeggiano.

Premete  per aumentare, e  per diminuire la percentuale.

Es.: se le stazioni in PI sono impostate a 10 minuti, e aumentate la percentuale a 150%, esse lavoreranno 15 minuti ognuna (nuovo 100%).

Premere  per saltare alla modalità MANUALE .

INFORMAZIONI IMPORTANTI

- Il tasto , guida nelle diverse fasi di programmazione.
- Ritorno automatico: se per 3 minuti non toccate nessun tasto, il programmatore tornerà automaticamente alla modalità AUTO, ad eccezione del modo MANUALE.
- Avanzamento Quick Digit: tenendo premuto  o , le cifre avanzeranno velocemente.
- Ripristino display: tenendo premuti  e  simultaneamente per qualche secondo, le cifre sul display saranno resettate a OFF.
- Operazione di cancellazione: in modalità Auto Run, premete  e  simultaneamente fino a che la freccia comincia a lampeggiare. Lampeggerà 5 volte per completare il programma di cancellazione.

USA: (Tel) 1-909-785-3623 (Fax) 1-909-785-3795

Europe: (Tel) 00-39-765-455201 (Fax) 00-39-765-455386

Australia: (Tel) 08-8300-3633 (Fax) 08-8243-2940

Irritrol
SYSTEMS

© 2005 Irritrol Systems P/N 373-0218 Rev. B