

CP LED Wall Light DESIGNER PREMIUM



PROJECT

CATALOG #

TYPE

NOTES

The CP is engineered to bring light to walkways, stairways, and decks. In addition, the CP is helpful for lighting other areas with high foot traffic hazards that do not have an adjacent planter area for path lighting, or trees and trellises from which to down light.

Quick Facts

- Stamped copper construction
- Cree® Integrated LEDs
- Natural, powder coated, or antiqued brass
- Color temperature options
- Compatible with Luxor® technology
- Phase and PWM dimmable
- Input voltage: 10-15V

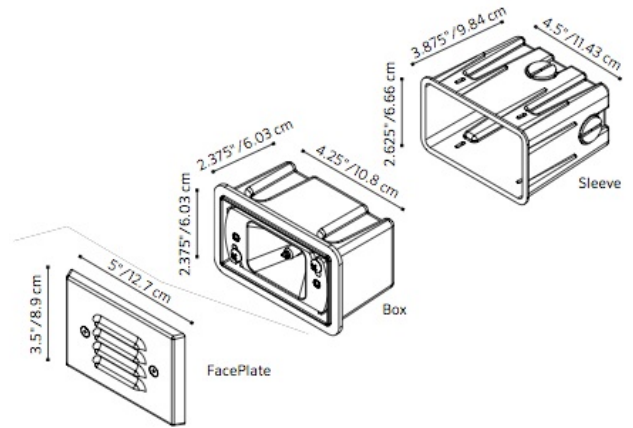

Note: Faceplate width with louver is 0.50"

CP LED Wall Light SPECIFICATIONS

Number of LEDs	1
Halogen Lumen Output Equivalent	10W
Useful LED Life (L70)	50,000 hrs avg
Input Voltage	10 to 15V
VA Total (Use this number to size the transformer)	2.4
Watts Used	2.0
Lumens per Watt (Efficacy)	5
Max Lumens	10
CRI (Ra)	86
CCT	
Amber Filter	2700K

CP LED Wall Light SPECIFICATIONS

About FX Luminaire

As a leading manufacturer of landscape and architectural lighting, FX Luminaire provides innovative products, resources, and support to help customers bring their visions to life. The company offers a range of specification-driven solutions, including fixtures, controls, and accessories, to enhance residential and commercial landscapes.

Materials

Stamped C110 copper faceplate, A380 aluminum housing, PBT construction box/sleeve, and stainless steel hardware.

LED

Integrated module with Cree LEDs. Gold-plated connectors and conformal coated for maximum reliability and corrosion resistance. Proprietary on-board intelligent driver uses firmware-controlled temperature regulation, maximizing LED life. Field upgradeable and replaceable, the LEDs are rated to 50,000 hrs. Maximum drive current: 1 A.

Optics

Polycarbonate color temperature adjustment lenses included with fixture: 2,700K (pre-installed), 3,900K (no lens), 4,500K and 5,200K options specified separately. Color temperature lenses are field serviceable.

Finish

Options of natural copper finish, antiqued finish with brushed (Antique Bronze) or tumbled (Antique Tumbled) effect, or TGIC powder coat finish. Antique finishes sealed with a clear TGIC powder coat layer.

Hardware

Tamper-resistant stainless steel fasteners included.

Wiring

18 AWG (1 mm); SPT-1W; 220°F (105°C); 300V; 10' (3 m) length

Sockets

Socket contains MoistureBlock™ technology, preventing moisture from wicking up into sealed areas of the fixture.

Power

Input 10–15 VAC/VDC, 50/60 Hz. Remote transformer required (specify separately).

Housing

Die-cast aluminum housing with capacity for one 1LED integrated LEDs.

Weight

2.3 lbs. (1.0 kg)

Lens

Polycarbonate lens with shock resistance and high tolerance for thermal expansion and stress.

International Compliance

Compliant per IEC 60598-1 and IEC 60598-2-7 when used with International Wall Kit ("EKITWALL").

Ambient Operating Temperature

0°F to 140°F (-18°C to 60°C)

Installation Requirements

Compliant per IEC 60598-1 and IEC 60598-2-7 when used with International Wall Kit ("EKITWALL").

Control

ZD option utilizes Luxor technology to zone light fixtures in up to 250 groups, and dim each group in 1% increments between 0 and 100%.











Warranty

Listings



CP LED Wall Light ORDERING INFORMATION

[field_spec_builder_mount] [field_spec_builder_mount]

Fixture	Control	Power	Finish
CP	ZD Zone/Dim with Luxor	1 LED 2.0W/2.4VA	BZ Bronze Metallic 
			FB Black 
			DG Desert Granite 
			WI Weathered Iron 
			SB Sedona Brown 
			FW Flat White 
			SV Silver 
			AB Antique Bronze 
			AT Antique Tumbled 
			CU Copper 
			NP Nickel Plate 



EXAMPLE FIXTURE CONFIGURATION: CP-ZD-1LED-FB

*Includes Sleeve With Cover (250022040000)

CP 1LED - Illuminance at a Distance

Distance	Center Beam fc	Beam Width	
Feet (Meters)	Foot-Candles (Lux)	Vertical : 62.7 °	Horizontal : 90.1 °
2.0' (0.6 m)	0.21 fc	2.4 ft	4.0 ft
4.0' (1.2 m)	0.05 fc	4.9 ft	8.0 ft
6.0' (1.8 m)	0.02 fc	7.3 ft	12.0 ft
8.0' (2.4 m)	0.01 fc	9.7 ft	16.0 ft
10.0' (3.1 m)	0.01 fc	12.2 ft	20.0 ft
12.0' (3.7 m)	0.01 fc	14.6 ft	24.1 ft



CP LED Wall Light ORDERING INFORMATION



MOUNTING OPTIONS: Specify Separately

Mounts	Catalog No.	Mounts	Catalog No.
CE Certified Installation Kit for Wall Lights	eKitWall		

CP LED Wall Light ORDERING INFORMATION

POWER OPTIONS: Specify Separately

Power	Catalog No.	
Luxor CUBE- Low-voltage	LCM-LV	
Step-Down Transformer, UV (120/277 V to 12 V)	ST-UV	

Power	Catalog No.	
Plug-In Transformer, 6 W	MT-6W	
Surge Protection Module	SURGE-MOD	
-		