

DURA SLOPE™

CATCH BASIN GENERAL SPECIFICATIONS

The NDS Dura Slope™ in-line catch basin is designed to fit all depth ranges of the Dura Slope™ trench drain sections. Catch basin inlets are designed to be sized as required to accept the Dura Slope™ trench drain section. The Dura Slope™ catch basin is 2 feet long and 2 feet deep with an outlet on both sides of the basin. One Universal Adapter Plug, one blank grate insert and two grate screws are included with each Dura Slope™ in-line catch basin. The NDS universal basin outlets are used to adapt the catch basin to 3", 4", 6" and 8" pipe.

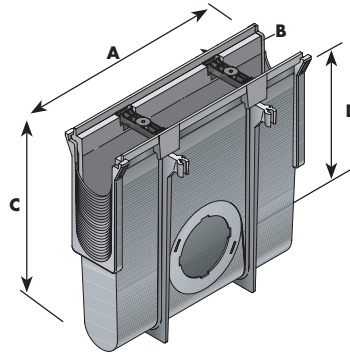

DIMENSION KEY

A: Length	24"
B: Width	6"
C: Depth	27"
D: Outlet Depth	16 7/8"

PART NO.	CATCH BASIN DIMENSIONS & WEIGHTS				CATCH BASIN HOLDING CAPACITY AT SEAT OF GRATE				PRODUCT CLASS			
	DIMENSIONS (INCHES)				AVG WEIGHT LBS	COLOR	MATERIAL	GAL		CU FEET	LITERS	CU METERS
A	B	C	D	GAL					CU FEET			
DS-340	24	6	27	16 7/8	12.0	Gray	Polyethylene	8.62	1.15	32.61	.0330	25DS

CATCH BASIN OUTFLOW CAPACITY

NO. OF OUTLETS	1243/1245 3" OUTLET				1266 6" OUTLET				1888 8" OUTLET			
	GPM	LPM	FPS	MPS	GPM	LPM	FPS	MPS	GPM	LPM	FPS	MPS
1 outlet	44	167	2	0.6096	160	606	2	0.6096	280	1060	2	0.6096
2 outlet	88	334	2	1.2192	320	1212	2	1.2192	560	1120	2	1.2192

TRASH BUCKET

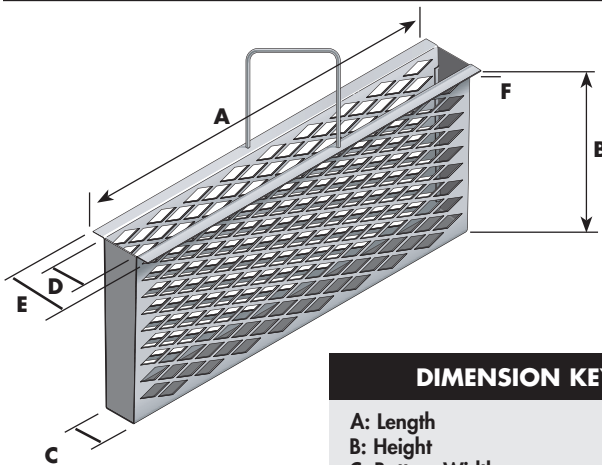

Dura Slope Trash Bucket is made to fit inside the Dura Slope Catch Basin (part number DS-340). It has a handle for easy removal to clean leaves and debris; it requires removal of the grate. Made of zinc plated steel, it is durable to climatic conditions. The Trash bucket is not intended for use with any of the Dura Slope channels.

Note – DS-240 Trash Bucket is not for use with the DS-200 Ductile Iron Frame.

DIMENSION KEY



A: Length	22"
B: Height	10"
C: Bottom Width	2"
D: Inside Top Width	2 1/4"
E: Outside Top Width	3 3/4"
F: Metal Thickness	0.04"

TRASH BUCKET SPECIFICATIONS

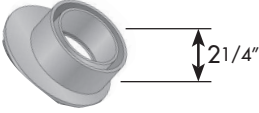
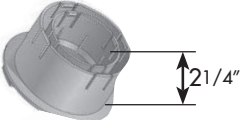
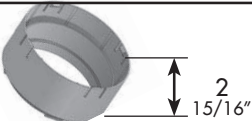

PART NO.	WEIGHT		COLOR	MATERIAL	PRODUCT CLASS
	lbs	kg			
DS-240	5.0	2.27	Steel	Plated Steel	25DS

CATCH BASIN & CHANNEL ACCESSORIES



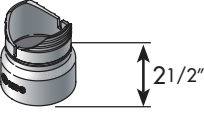

OUTLETS

	Part No.	Description	Color	Pkg. Qty.	Wt. Ea. (lbs.)	Material	Product Class
	1245	3" & 4" Offset Universal Outlet Fits 3" & 4" Corrugated pipe, 3" & 4" Sewer and Drain Pipe, 4" SCH. 40 Pipe, 4" Triple Wall Pipe. Allows for adjusting inlet height.	Black	20	0.55	HIPS	10ND
	1243	3" & 4" Universal Locking Outlet Fits 3" & 4" Corrugated pipe, 3" & 4" Sewer and Drain Pipe, 4" SCH. 40 Pipe and 3" & 4" Triple Wall Pipe. Note: Locking Outlet snaps onto most 3" & 4" Corrugated Pipe.	Black	20	0.70	HIPS	10ND
	1266	6" Universal Locking Outlet Fits 6" Sewer and Drain Pipe, 6" Corrugated Pipe. Note: Locking Outlet snaps onto most 6" Corrugated Pipe.	Black	20	0.75	HIPS	10ND
	1888	8" Universal Adapter Fits 8" Sewer and Drain Pipe, 8" Corrugated Pipe.	Black	8	1.25	HIPS	10ND

PLUGS & END CAPS

	DS-227	Universal End Outlet Slides in to upstream (female) end of channel section. Requires DS-123 screws when applying to male end of channel section.	Gray	6 (box)	.75	HDPE	25DS
	DS-126	Sure Fit™ Bottom Outlet Adapter Fits to 4" S&D Pipe Note: 4" Hole Saw needed to drill hole in channel.	Gray	6	.53	PVC	25DS
	DS-224	Universal End Cap Slides in to upstream (female) end of channel section. Requires DS-123 screws when applying to downstream (male) end of channel section.	Gray	8	.63	HDPE	25DS
	1206	6" Universal Adapter Plug	Black	20	0.35	HIPS	10ND

GRATE LOCKS & SCREWS

	DS-122	ProFit™ Grate Lock Screws ordered separately. Note: 4 included with each channel. 2 included with each catch basin.	Black	8	.8	ABS	25DS
	629	Grate Screws 1/4" - 20 x 11/2 Grate screws are included with Dura Slope channel (4 screws per channel). For all Dura Slope grates except DS-221. Do not use with ductile iron frame.	Steel	40	.07	Stainless Steel	25PF
	DS-225	Dura Slope Ductile Iron Frame Grate Screws 1/4" - 20 x 21/2 Use with DS-200 DI Frame. 2 screws per piece of frame/grate.	Steel	12	1	Stainless Steel	25DS
	DS-123	Ductile Iron Frame and Universal End Cap Screws #6, 3/4" Use on DS-224 & DS-227 universal end cap downstream for (male) end.	Steel	12	1	Zinc Plated	25DS
	DS-650	Flat Drilled Spanner End Cap Screws #6, 3/4" Drill bit included with each package.	Steel	12	1	Stainless Steel	25DS