











SnowMaster®/Snow Max Snowthrowers

Souffleuse à neige SnowMaster®/Snow Max

Quick Start Guide/Guide de Démarrage Rapide

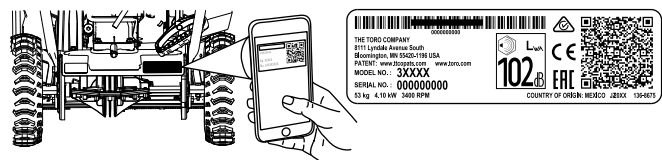
<p>* </p>	<p>Read the Operator's Manual. Lisez le manuel de l'utilisateur.</p>		<p>Thrown object hazard Risque de projections d'objet</p>
	<p>Cutting/dismemberment hazards of hand or foot, impeller and auger Risque de coupure/mutilation des mains ou des pieds par la turbine et la vis sans fin</p>		<p>Keep bystanders a safe distance away from the machine. Tenez tout le monde à une distance suffisante de la machine.</p>
	<p>Do not place your hand in the chute; shut off the engine before leaving the operator's position and use a tool to clear the chute. Ne placez pas la main dans la goulotte ; coupez le moteur avant de quitter la position d'utilisation et dégagez la goulotte avec un outil.</p>		<p>Shut off the engine and wait for the auger to stop before leaving the machine. Coupez le moteur et attendez l'arrêt complet de la vis sans fin avant de quitter la machine.</p>
	<p>Remove the ignition key and read the instructions before servicing or performing maintenance. Retirez la clé de contact et lisez les instructions avant de procéder à l'entretien ou à des révisions.</p>		<p>Stay away from moving parts; keep all guards and shields in place. Ne vous approchez pas des pièces mobiles, et laissez toutes les protections et tous les capots en place.</p>
	<p>Fuel spill hazard—do not tip the machine backward. Risque de déversement de carburant – n'inclinez pas la machine en arrière.</p>	<div style="border: 1px solid black; padding: 5px;"> <p style="text-align: center;">⚠ WARNING</p> <p style="text-align: center;">CALIFORNIA Proposition 65 Warning</p> <p style="text-align: center;">This product contains a chemical or chemicals known to the State of California to cause cancer, birth defects, or reproductive harm.</p> <p style="text-align: center;">The engine exhaust from this product contains chemicals known to the State of California to cause cancer, birth defects, or other reproductive harm.</p> </div>	
 <p>THE TORO COMPANY 811 Lyndale Avenue South Bloomington, MN 55420-1191 USA PART#: www.toro.com www.toro.com MODEL NO.: 3XXXX SERIAL NO.: 000000000 53 kg, 4.16 kW, 3000 RPM 102 B ENE COUNTRY OF ORIGIN: MEXICO 285X 194615</p>			
<p>For the Operator's Manual, the complete warranty details, or to register your product, use the QR code or visit www.Toro.com. You may also call us at 1-888-384-9939 to request a written copy of the product warranty.</p> <p>Pour vous procurer le Manuel de l'utilisateur, des détails complets sur la garantie ou pour enregistrer votre produit, utilisez le code QR ou rendez-vous sur www.Toro.com. Vous pouvez aussi nous appeler au 1-888-384-9939 pour demander une copie écrite de la garantie produit.</p>			

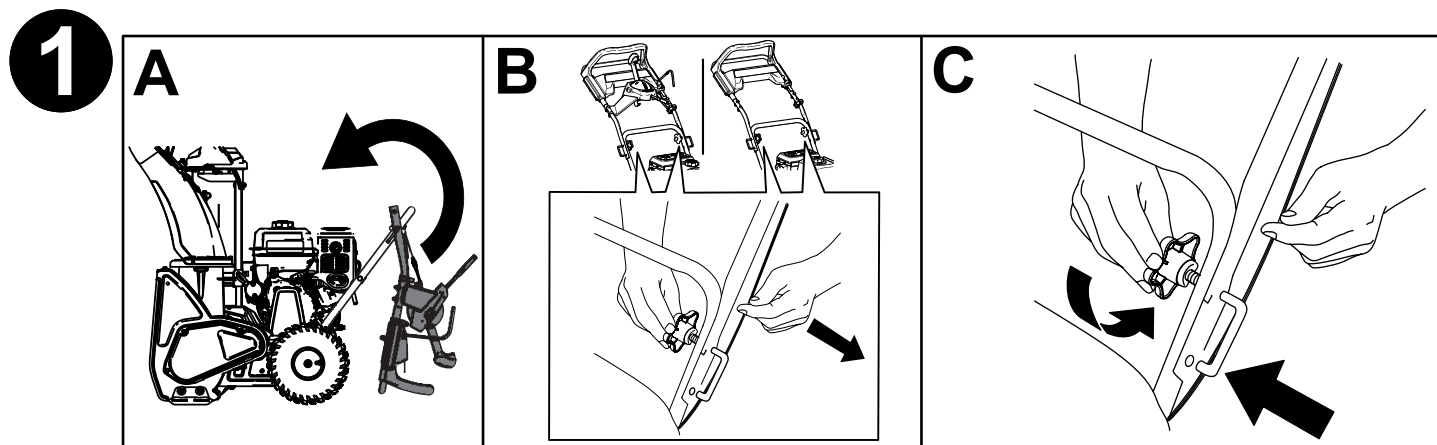

g216105



2

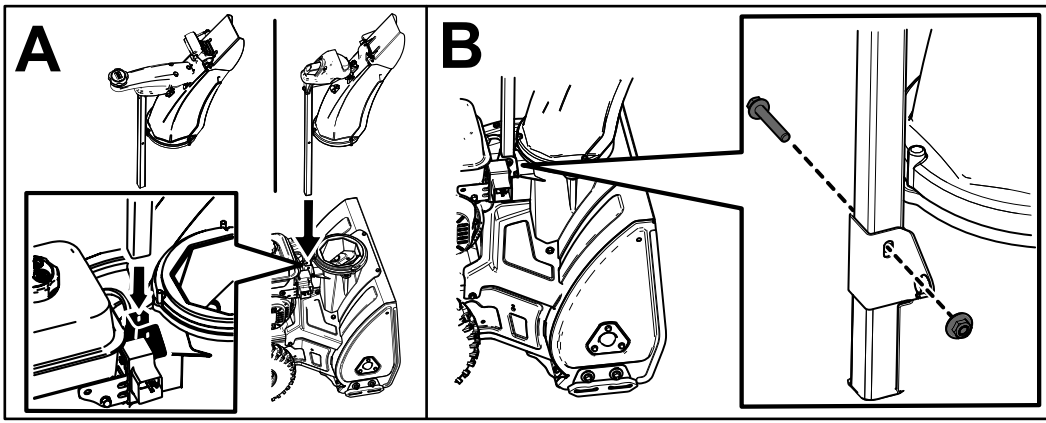
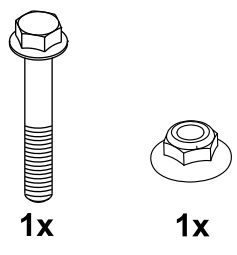

g216106

3

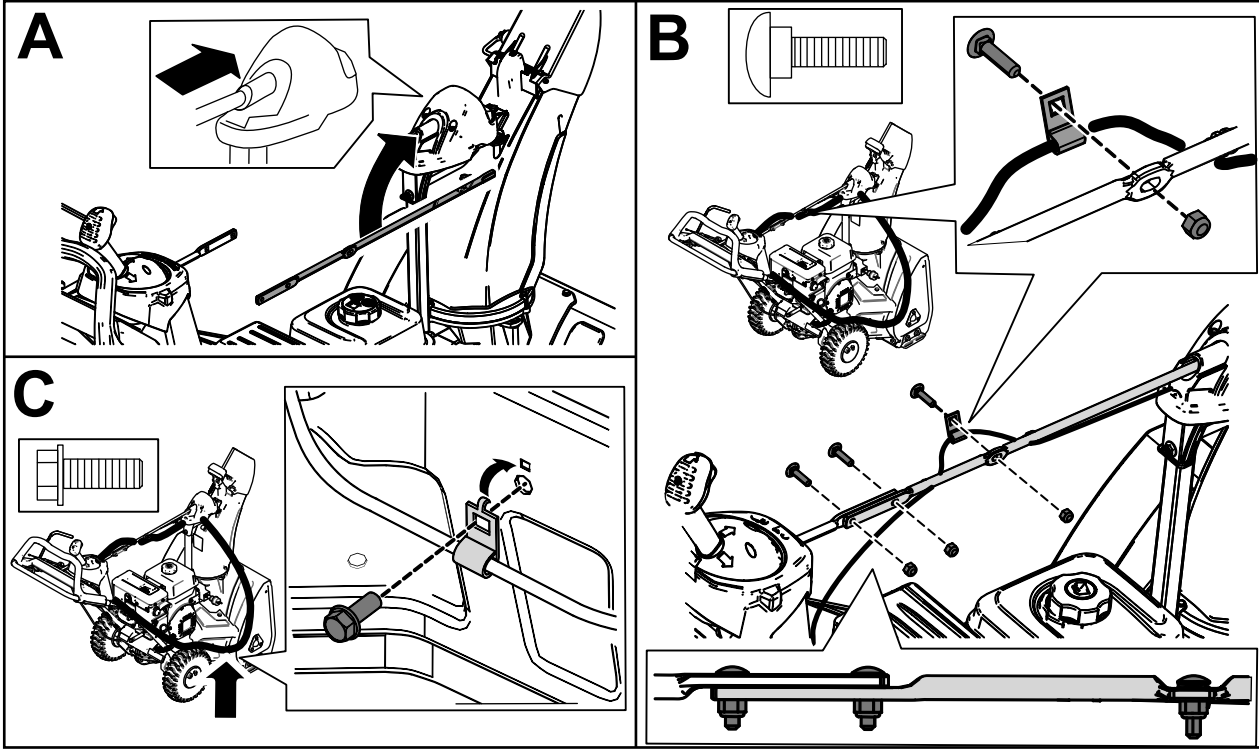
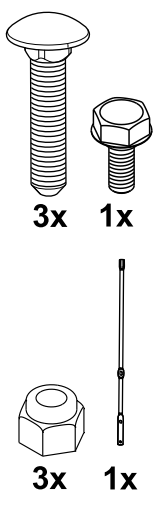

g216107

4

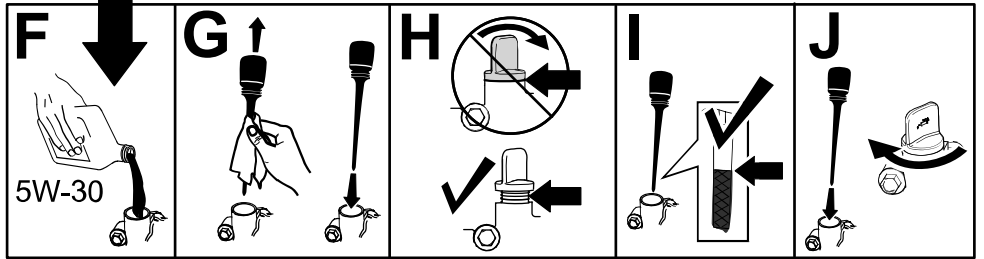
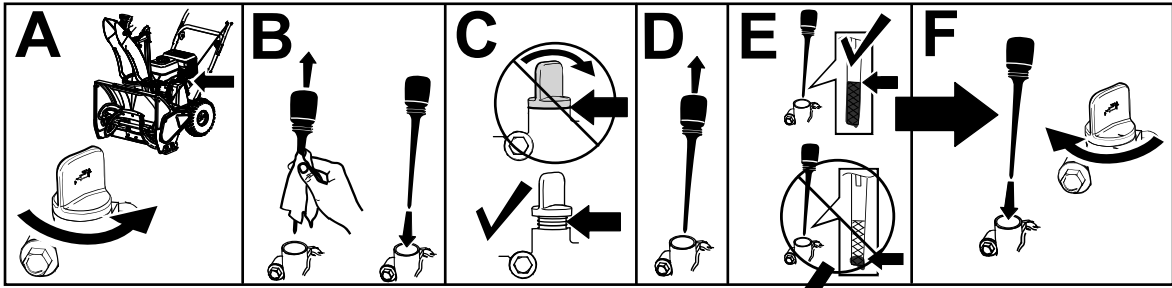

g216108

5

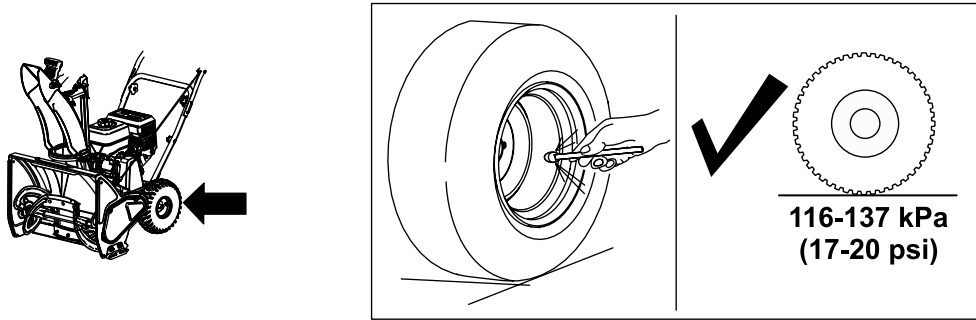

g216109

6

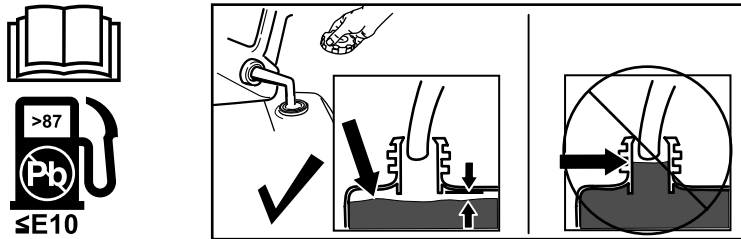

g216110

7

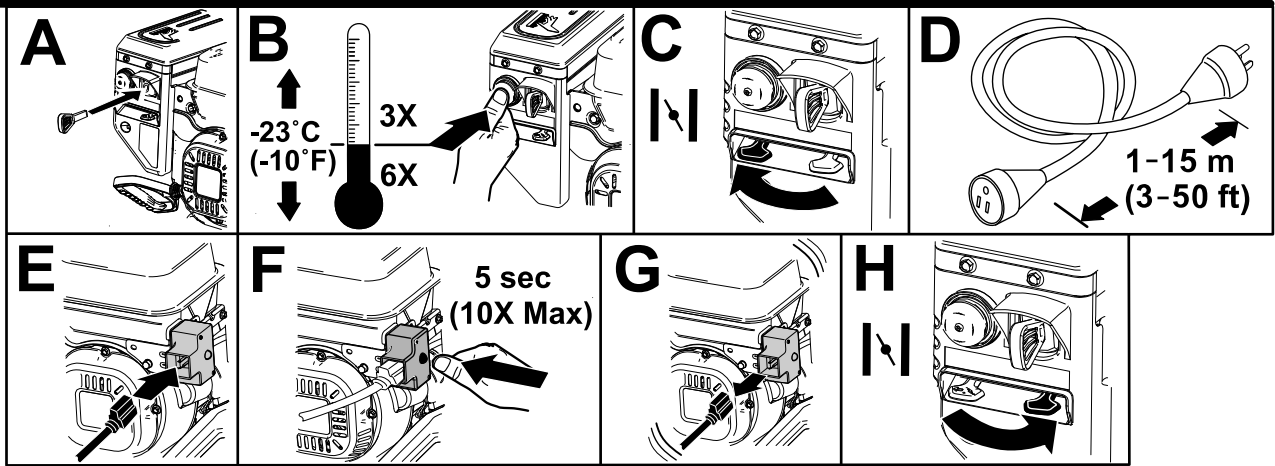

7

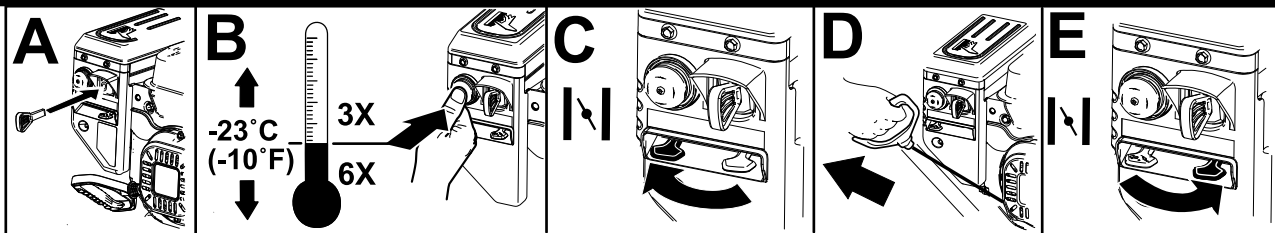

g216111

8

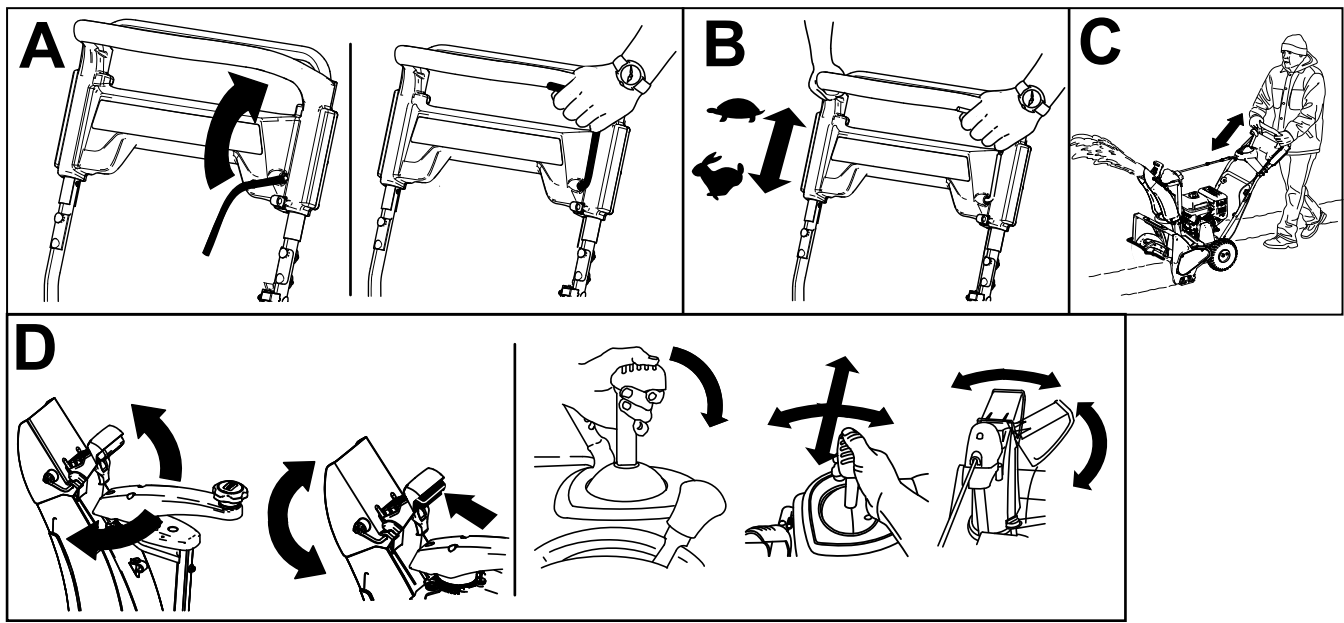

g216112

9

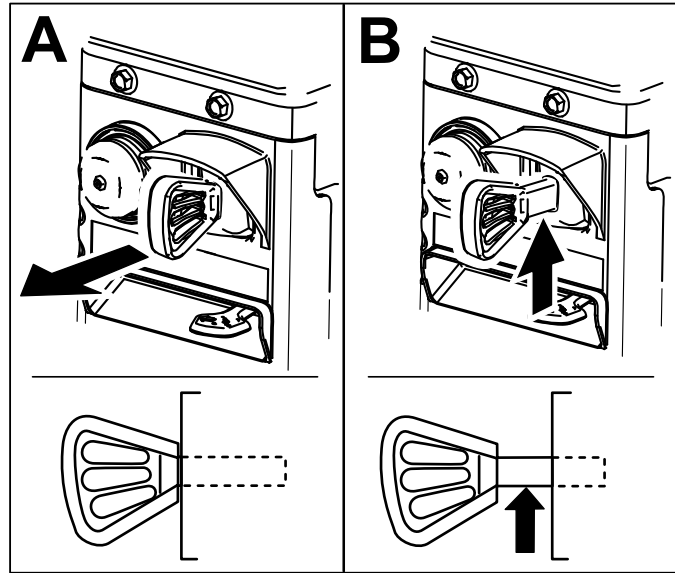

g216113

Notes:



Count on it.